

Product Image

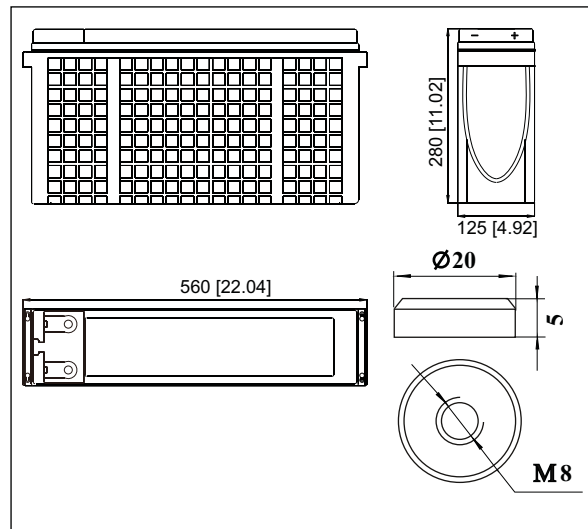

Product Dimensions



Characteristics

Nominal Voltage		12V
Nominal Capacity (10 hour rate)		155Ah
Capacity 25°C (77°F)	10 hour rate (15.2A)	155Ah
	5 hour rate (28.5A)	142.5Ah
	1 hour rate (105.6A)	105.6Ah
Internal Resistance	Full Charged Battery 25°C	≤2.5m Ω
Capacity affected by Temperature (10 hour)	40°C (104°F)	102%
	25°C (77°F)	100%
	0°C (32°F)	85%
	-15°C (5°F)	65%
Self-Discharge 25°C (77°F) Capacity	after 3 month storage	90%
	after 6 month storage	80%
	after 12 month storage	62%
Charge (Constant Voltage) 25°C (77°F)	Float	Initial Charging Current Less than 32A Voltage 13.6-13.8V
	Cycle	Initial Charging Current Less than 32A Voltage 14.4-14.9V

Packaging

Battery Dimensions	Length	550mm
	Width	110mm
	Height	287mm
	Total Height	287mm
Box Dimensions	Length	565mm
	Width	125mm
	Height	347mm
Quantity Per Box		1 PC per box
Net weight Per Cell		45.4kg ± 400g
Net weight Per Box		45.4kg
Gross Weight		46.1kg

Discharge Constant Current per Cell (Amperes at 77°F25°C)

F.V/Time	5min	10min	15min	30min	45min	1h	2h	3h	5h	8h	10h	20h
1.60V	457.6	352.0	264.9	176.0	123.2	105.6	66.0	45.2	30.2	20.3	16.8	8.80
1.65V	449.3	345.6	260.0	172.8	121.0	103.7	64.8	44.4	29.6	19.9	16.5	8.64
1.70V	441.0	339.2	255.2	169.6	118.7	101.8	63.6	43.6	29.1	19.5	16.1	8.48
1.75V	432.6	332.8	250.4	166.4	116.5	99.8	62.4	42.8	28.5	19.2	15.8	8.32
1.80V	416.0	320.0	240.8	160.0	112.0	96.0	60.0	41.1	27.4	18.4	15.2	8.00

Discharge Constant Power per Cell (Watts at 77°F 25°)

F.V/Time	5min	10min	15min	30min	45min	1h	2h	3h	5h	8h	10h	20h
1.60V	880.9	677.6	509.8	338.8	237.2	203.3	127.1	87.1	58.0	39.0	32.2	16.9
1.65V	864.9	665.3	500.6	332.6	232.8	199.6	124.7	85.5	57.0	38.3	31.7	16.6
1.70V	848.8	653.0	491.3	326.5	228.5	195.9	122.4	83.9	55.9	37.6	31.1	16.3
1.75V	832.8	640.6	482.0	320.3	224.2	192.2	120.1	82.3	54.9	36.9	30.5	16.0
1.80V	800.8	616.0	463.5	308.0	215.6	184.8	115.5	79.2	52.8	35.5	29.3	15.4

Note The above data are average values, and can be obtained within 3 charge/discharge cycles. These are not minimum values. Cell and battery designs/specifications are subject to modification without notice. Contact **CBB** For the latest information.

Performance Characteristics

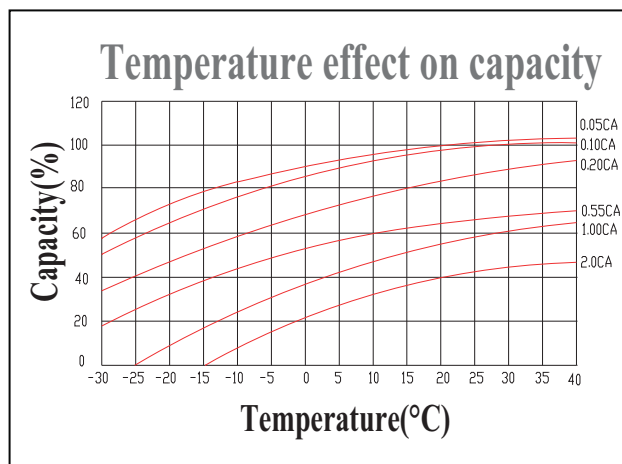
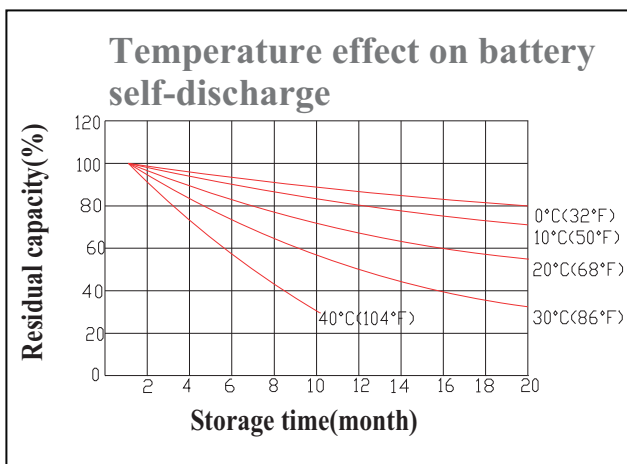
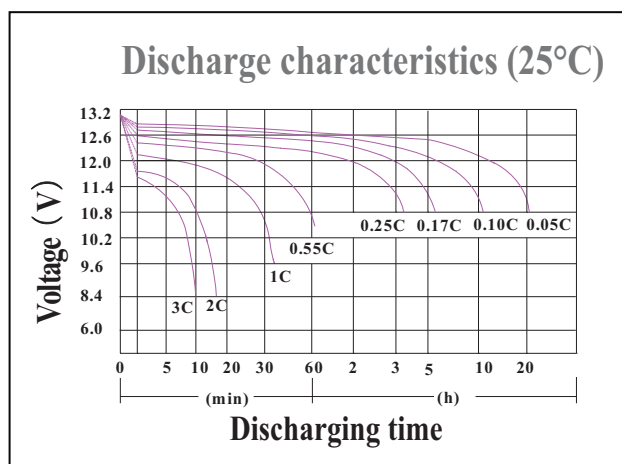
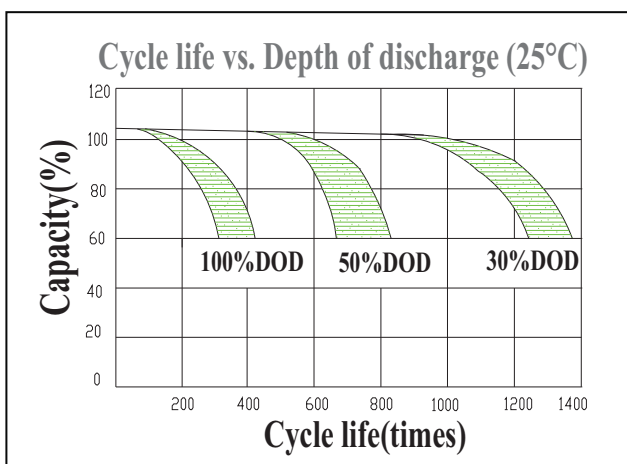
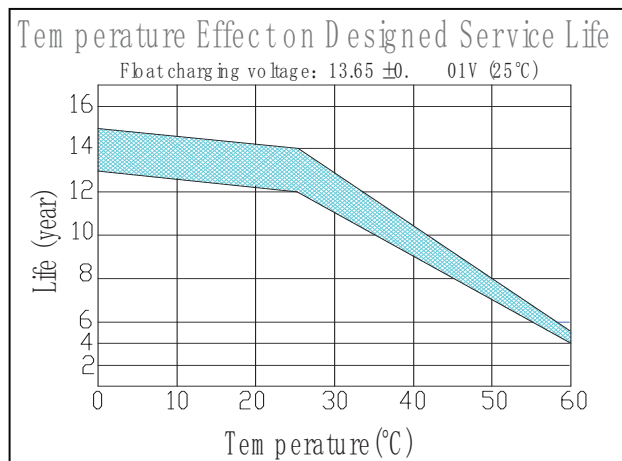
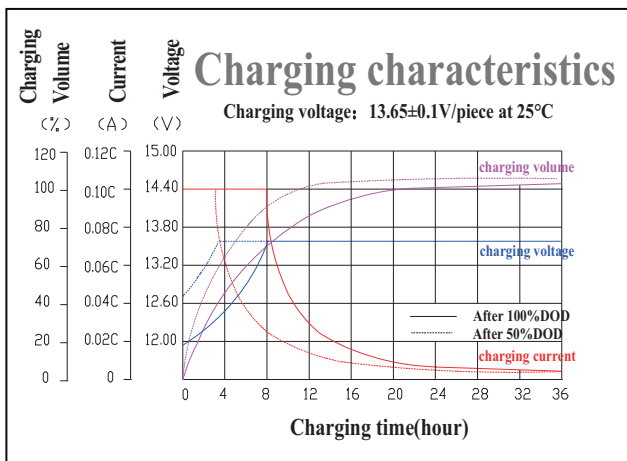

Battery Construction

Component	Positive plate	Negative plate	Container	Cover	Safety valve	Terminal	Separator	Electrolyte
Raw material	Lead dioxide	Lead	ABS	ABS	Si-Rubber	Copper	Fiberglass	GEL

CBB Battery Technology Co.,Ltd.

RM205, Yushan Business Bldg, 108 Dabeil Road,
 Panyu, Guangzhou 511365, Guangdong Province, China
 TEL: 0086-20-84888946 FAX: 0086-20-62824569