

GENERAL FEATURES

- AGM technology, Maintenance-free operation
- Front access terminal for standard 19 inch or 23 inch power cabinets
- high power density
- Long float service life
- Low self discharge

APPLICATIONS

- Telecom Control Equipments
- UPS systems
- Communication Equipments
- Medical Equipments
- Emergency Power Systems
- Network connection equipment of communication system



DIMENSIONS & WEIGHT

Length(mm)	552±1
Width(mm)	110±1
Height(mm)	239±1
Total Height(mm)	239±1
Weight(kg)	38.0±3%

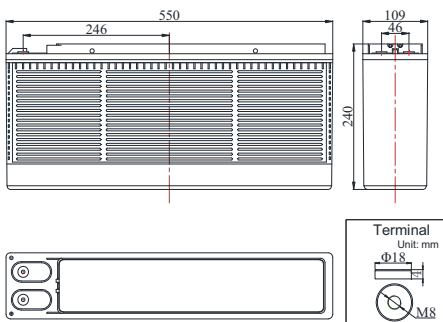

COMPLIED STANDARDS

IEC 60896-21/22	JIS C8704
YD/T799	BS6290 part4
GB/T 19638	UL 1989

TECHNICAL SPECIFICATIONS



Nominal Voltage		12V(6 cells per unit)
Design Floating Life @25°C		10 Years
Nominal Capacity @25°C(10 hour rate@12.5A,10.8V)		125Ah
Capacity @25°C	20hour rate (6.63A,10.8V)	132.6Ah
	5 hour rate (22.0A,10.5V)	110.0Ah
	1 hour rate (79.8A,9.6V)	79.8Ah
Internal Resistance	Full Charged Battery@25°C	≤4.8mΩ
Ambient Temperature	Discharge	-20°C~50°C
	Charge	-20°C~50°C
	Storage	-20°C~50°C
Max.Discharge Current@25°C		1250A(5s)
Capacity affected by Temperature (10 hr Capacity)	40°C	105%
	25°C	100%
	0°C	85%
	-15°C	65%
Self-Discharge@25°C per Month		3%
Charge (Constant Voltage) @25°C	Standby Use	Initial Charging Current Less than 25A Voltage 13.6-13.8V
	Cycle Use	Initial Charging Current Less than 25A Voltage 14.4-14.9V

BATTERY DISCHARGE TABEL

Discharge Constant Current per Cell (Amperes at 25°C)

F.V/Time	10min	15min	30min	45min	1h	2h	3h	5h	8h	10h	20h
1.60V	290.6	225.6	135.4	100.6	79.8	46.9	34.5	23.3	15.9	13.1	6.94
1.65V	268.9	213.1	130.9	96.8	77.4	45.4	33.4	22.9	15.8	12.9	6.88
1.70V	249.4	200.1	127.3	93.3	74.4	44.1	32.5	22.4	15.5	12.8	6.80
1.75V	232.9	187.5	120.6	89.1	71.4	43.0	31.8	22.0	15.3	12.6	6.74
1.80V	209.5	175.9	116.4	85.9	68.9	41.4	30.8	21.5	15.0	12.5	6.63

Discharge Constant Power per Cell (Watts at 25°C)

F.V/Time	10min	15min	30min	45min	1h	2h	3h	5h	8h	10h	20h
1.60V	522.8	431.4	263.9	191.1	153.0	88.9	65.9	44.9	31.0	25.6	13.4
1.65V	489.3	412.8	252.4	184.6	148.9	86.5	64.1	44.1	30.8	25.4	13.3
1.70V	458.1	384.6	242.0	178.8	143.8	84.5	62.6	43.5	30.4	25.1	13.1
1.75V	431.1	360.9	230.4	171.6	138.5	82.5	61.4	42.9	30.0	24.9	13.0
1.80V	390.3	338.8	221.0	165.9	134.0	79.8	59.6	42.0	29.6	24.8	12.9

Note The above data are average values, and can be obtained within 3 charge/discharge cycles. These are not minimum values. Cell and battery designs/specifications are subject to modification without notice. Contact **CBB** for the latest information.

PERFORMANCE CHARACTERISTICS

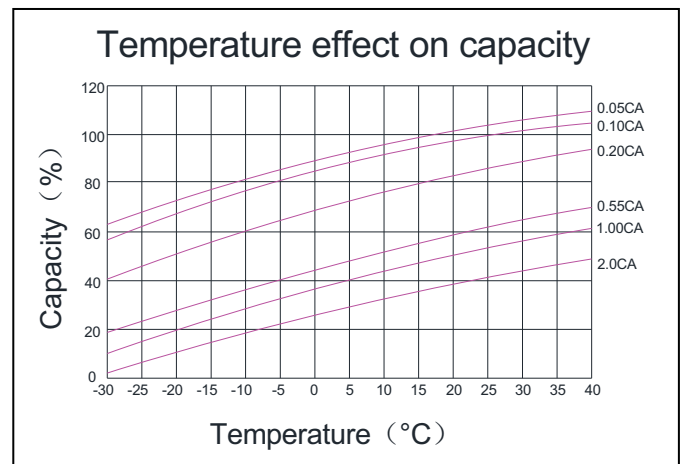
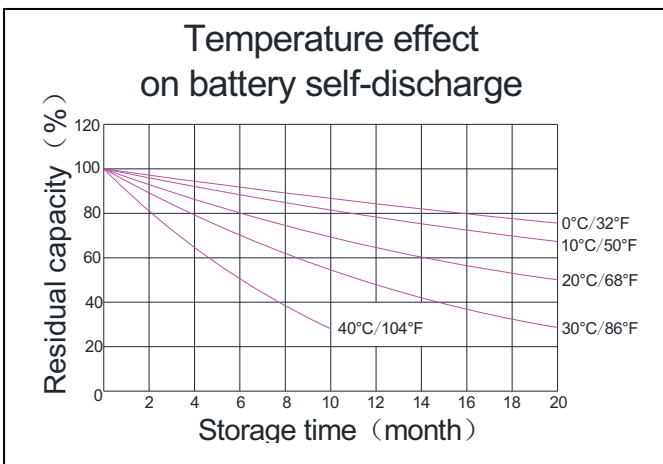
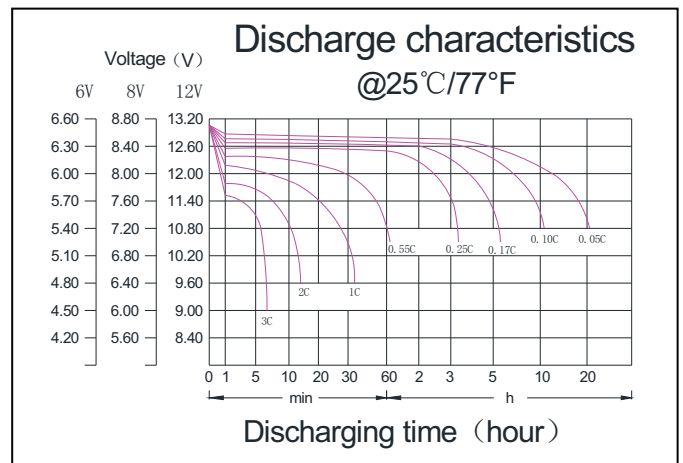
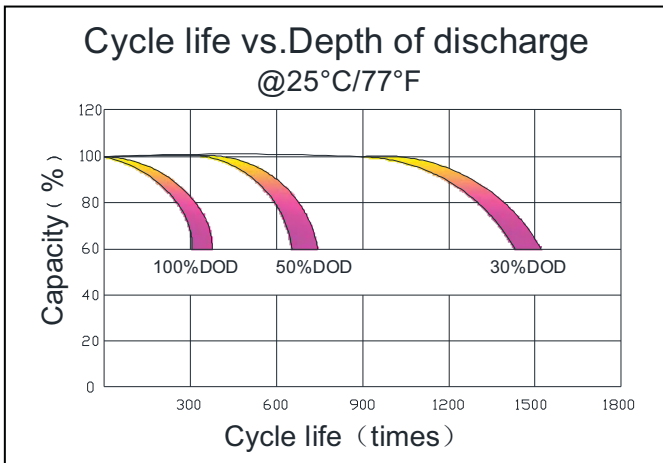
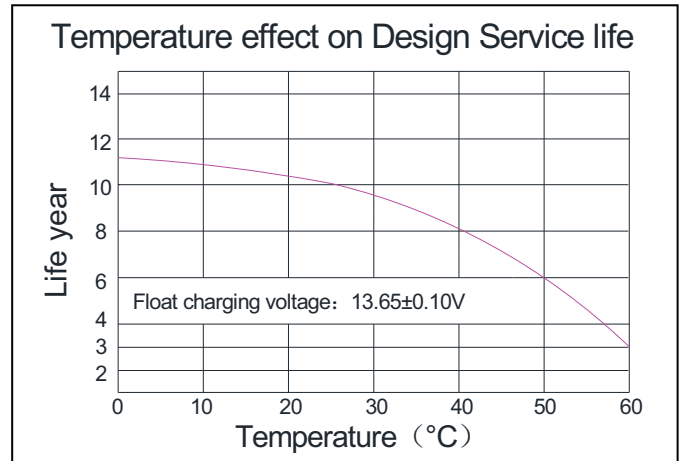
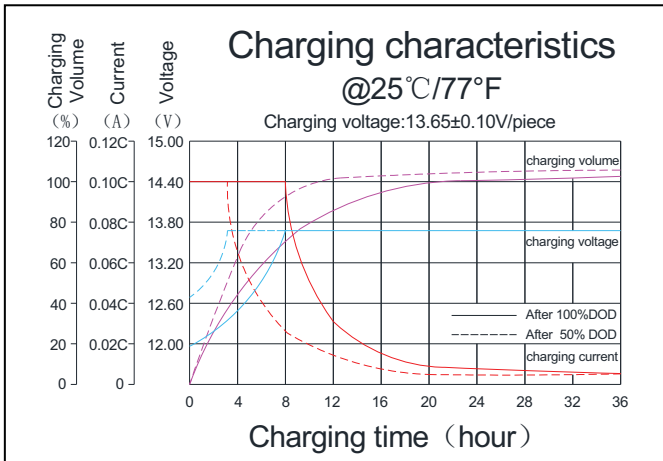

BATTERY CONSTRUCTION

Component	Positive plate	Negative plate	Container & Cover	Safety valve	Terminal	Separator	Electrolyte	Pillar seal
Features	Thick high Sn low Ca grid with special paste	Balanced Pb-Ca grid for improved recombination efficiency	ABS (UL94-V0 optional)	Flame Si-Rubber aging resister	Female Copper Insert M8(torque:7~9N.m)	Advanced AGM separator for high pressure cell design	Dilute high purity sulphuric acid	Two layers epoxy resin seal

CBB Battery Technology Co.,Ltd.

RM504,55 Hanxing Zhong Road,Zhongcun, Panyu,Guangzhou 511495 China
Tel: +86-020-84888946 Fax: +86-020-62824569

Koyama®

www.cbb-battery.com