

SANWOOD®

Rain test chamber



● **Technical parameters**

IPX1

Test Method: Vertical drop test

Test Equipment: Drop Test Equipment

Test Specimens Placed: Test specimens placed at 1r/min rotation sample holder,
keep distance between sample and drop port no more than 200mm.

Experiment Condition: Drop volume 10.5mm/mm

Test time: 10 min

IPX2

Test Method: 15° to Vertical drop test

Test Equipment: Drop Test Equipment

Test Specimens Placed: The surface of specimens placed 15° to Vertical,
keep distance between sample and drop port no more than 200mm,
1 surface finished test change to another surface, 4 cycle.

Experiment Condition: Drop volume 30.5mm/mm

Test time: 4 X 2.5 min (10 min)

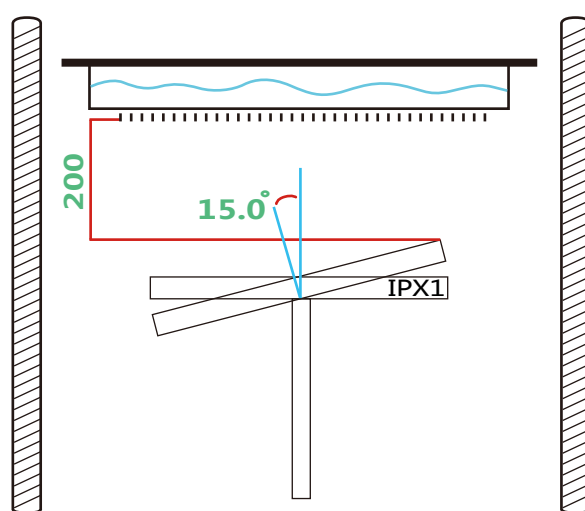

IPX1water dripping IPX2water dripping

Technical parameters

Model	SM-LY-1000-IP12
Internal Dimension	1000*1000*1000
Specimens Exposure Dimension	800*800*800
Drop Angel	0° ~15°
Drop hole number	2000pcs
Drip hole diameter	0.4mm
Water Drip Volume	1.9~3.8L/H

Controller



Adopt a colorPLC touch screen controller that supports multiple English, Korean and Russian and other languages of countries

Workbench

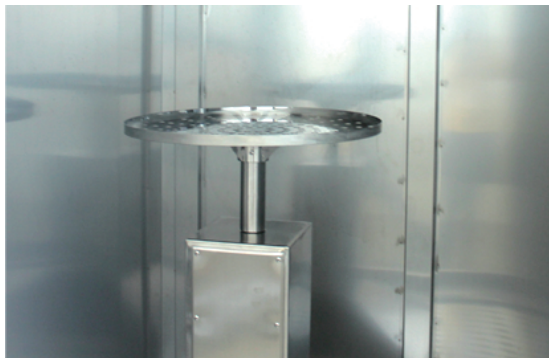

The sample was placed on a revolving working bench rain test

Nozzle



Stainless steel nozzle orifices can be replaced at any time according to requirements of the standard aperture

Water storage boxes

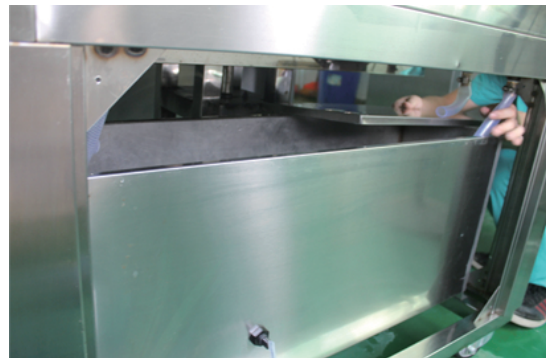

Stainless steel Water storage boxes, equipped with pumps, water filters, water float valve

Pendulum tube

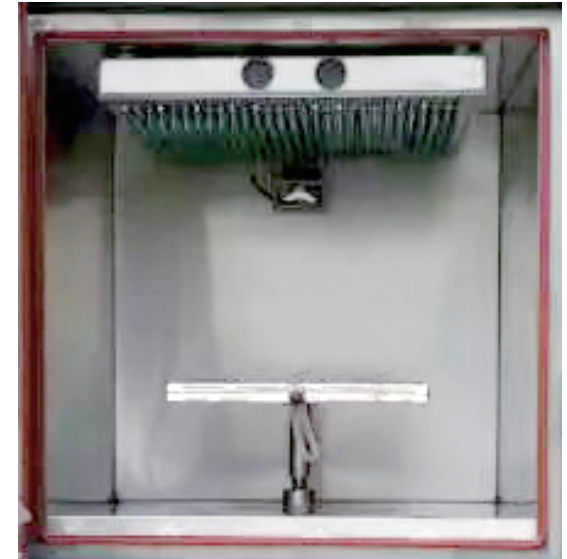

Adjusting the frequency using the frequency of the oscillating tube

Water inlet



Bottom inlet connection equipment faucet, water can enter the water holding tank

● Structure design

1. Shell: Spray galvanized color steel plate, the surface electrostatic spray processing
2. Liner: stainless steel SUS 304.
3. Thermal insulation layer: Polyurethane foam board thickness 100mm.
4. Seal: Toshiba high purity silicon rubber raw materials, effectively prevent aging.
5. Heater: Ni Cr alloy electric heater
6. Humidifier: Outer tube: SUS316 stainless steel seamless pipe Internal heating wire: Ni Cr alloy wire.

Pin hole

- Φ100mm (standard equipment)
Φ80mm Φ160mm (optional equipment)

Super large observation window

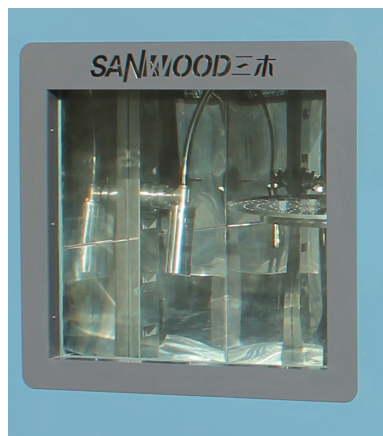

Observation window: Visual range:
W400*H800mm Console/ controller

Laboratory door upper state indicator light (optional)

When a person enters into the lab working, the light on the door of the laboratory indicates that in the room.

Modular design advantage

1. Shorten the delivery time and installation time
2. Easy to assemble and pass the circulating air duct system to facilitate the plug and play.
3. The modular structure is convenient for quality control.
4. High reliability from a high level of design conception

Handling ramp(Option)

For carrying heavy loads to the laboratory, there are cylinder drive automatic type and handle type

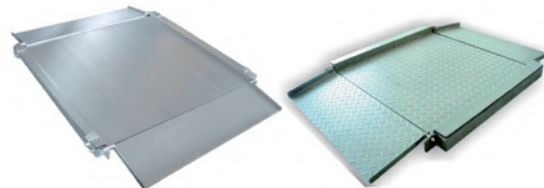

Pure water purifying device(C)



Electronic display (optional)



Display the temperature and humidity in the laboratory

Burglary indicator (optional)

When a person enters into the lab working, the light on the door of the laboratory indicates that in the room.

Preparation room (optional)

When opening or closing the door of the laboratory, the effect of temperature and humidity can be minimized, and it can also be used as the sample measuring chamber.

Door curtain (optional)

Preventing the temperature and humidity conditions in laboratory when opening and closing the laboratory doors.

Floor strength (optional)

When using the cars and other moving samples, in order to spread the weight of the concentrated, using the reinforced floor to prevent the floor deformation. Increase the number of floor support, spreading the load of the weight.

Wind speed variable device (optional)

The wind speed in the constant temperature and humidity chamber can be 4 speed change, then reduce the influence to the specimen.

Ceiling air distribution (optional)

Reduce the wind speed in the laboratory to reduce the impact to the sample, and making the wind speed in the room is uniform at the same time.

* When the blowing port is installed, the effective height of the room is reduced 200mm.

● Refrigeration design

- 1.Modular production, reliable quality, easy maintenance.
2. Piping vibration adopts 45% silver content of silver solder , To prevent joint leakage.
3. Enough space easy to operate.
4. Through the nitrogen when welding , ensure no tube oxidation.
5. Take all kinds of shock absorption process.
6. Take various anti-rust process.

Pressure relay



America EMERSON or Denmark DANFOSS

Mute cover

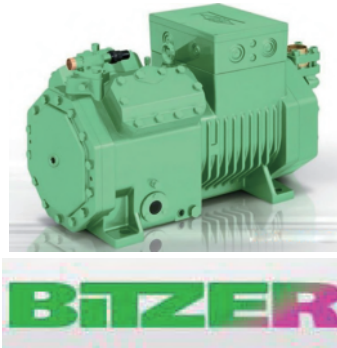

Germany Bizter compressor (standard)



Germany compressor (option)
Mute cover: reduce noise 10 db (option)

Evaporator

Design high efficiency finned heat exchanger

Electromagnetic valve



Italy CASTEL

Refrigerant

R404A
R23(-70)
Ozone depletion index was 0

Denmark DANFOSS brand



- 1.condenser
- 2.evaporator condenser(-70)
- 3.Evaporation pressure regulating valve
- 4.Thermal expansion valve
- 5.Dry filter
- 6.Condensation pressure regulating valve (water-cold)

The Experience you Rely on...

Sanwood Environmental Chambers was established in 1995, which integrated Taiwan and Japan technologies. We have been focus on the most secure and reliable climatic test chamber technology since established. And has become a private science and technology enterprises in Dongguan,Guangdong Province, which passed the ISO9001:2008 quality system certification.

Our products upgrade constantly and our customers come portable batteries, power batteries, battery, lithium batteries, lead-acid, new energy vehicles, electric bicycles, electric tools, electric systems, solar, military, universities research and other technology industries fields.

Having experienced nearly 20 years efforts, we have successfully developed a series of products:

- High and low temperature test chamber
- explosion-proof type thermal shock chamber
- an explosion-proof type temperature test box
- walk-in temperature and humidity chamber
- weather resistance test chamber
- battery thermal abuse test box
- explosion-proof type hot box
- Temperature&humidity&Vibration integrated test chamber
- dust test box
- vibration table
- rain test chamber
- ozone test box
- xenon lamp test chamber
- high temperature oven
- seawater immersion box

All of products meet GB31241、IE62133、QCT/743、UN38.3、UL2054 Standard. And we have had a good cooperation with ATL, Sony, Sunwoda, Desay, Samsung, BYD, Toyota, Yutong Bus, Nissan, Guangdong Province entry-exit, Tsinghua University, Henan University, Chinese Academy of Sciences, Central South University Successively.

Enterprise vision:

Sanwood Technology has established a large production base in Dongguan after many years efforts. The plant area reached more than 12000 square meters. The foreign trade branch and foreign service agencies were established in 2010. And branches successively established in Taiwan, Suzhou, Hunan, Hubei, Beijing, Henan. Excellent products and good after-sales service make us won the recognition and trust of customers. Products are exported to more than 30 countries, such as Russia, Singapore, the United States, Turkey, Denmark, Vietnam, India, Malaysia, Kazakhstan, Austria, Canada, etc. In the age with fierce competitions, Sanwood thrived little by little and aims to become the leading brand in the safety and reliability environmental test equipment industry all over the world.



SANWOOD®

Focusing on the innovation of environmental reliability test

Sanwood(HK)Industrial Corporation.,Limited
Guang dong Sanwood Technology Corporation.,limited

ADD:Changping Science&Technology park,Changping,
Dongguan city,Guangdong province,China

TEL:+86+769-81182799

FAX:+86+769-82987199

E-mail:info@climatic-chambers.com.tw

www.climatic-chambers.com.tw

www.environmental-chambers.ru