

GENERAL FEATURES

- Optimized plate achieve low IR
- 30% increased power output at 15 min
- Deep Discharge Recovery
- High Power Density
- Wide operating temperature

APPLICATIONS

- UPS & EPS
- Emergency lighting Systems
- Medical Equipment
- The office computer
- Cable TV Systems
- Alarm Systems



DIMENSIONS & WEIGHT

Length(mm)	165±1
Width(mm)	126±1
Height(mm)	174±1
Total Height(mm)	174±1
Weight(kg)	8.7±3%

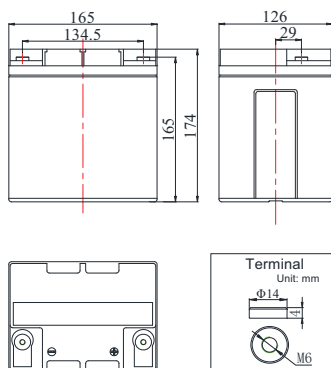

COMPLIED STANDARDS

IEC 60896-21/22	JIS C8704
YD/T799	BS6290 part4
GB/T 19638	UL 1989

TECHNICAL SPECIFICATIONS



Nominal Voltage		12V(6 cells per unit)
Design Floating Life @25°C		12 Years
Watts/cell@25°C(@15min,10.02V)		115W
Capacity @25°C	10 hour rate (2.8A,10.8V)	28Ah
	3 hour rate (8.2A,10.5V)	24.6Ah
	1 hour rate (21.3A,9.6V)	21.3Ah
Internal Resistance	Full Charged Battery@25°C	≤9.8mΩ
Ambient Temperature	Discharge	-20°C~50°C
	Charge	-20°C~50°C
	Storage	-20°C~50°C
Max.Discharge Current@25°C		420A(5s)
Capacity affected by Temperature (10 hr Capacity)	40°C	102%
	25°C	100%
	0°C	85%
	-15°C	65%
Self-Discharge@25°C per Month		3%
Charge (Constant Voltage) @25°C	Standby Use	Initial Charging Current Less than 7.0A Voltage 13.6-13.8V
	Cycle Use	Initial Charging Current Less than 7.0A Voltage 14.4-14.9V

BATTERY DISCHARGE TABEL

Discharge Constant Power per Cell (Watts at 25°C)

F.V/Time	5min	10min	15min	20min	25min	30min	45min	60min	90min	120min	180min	600min
1.60V	196.6	151.8	117.0	96.9	82.4	73.5	55.4	45.3	32.1	25.2	17.3	6.5
1.67V	193.0	149.0	115.0	95.7	80.8	72.1	54.3	44.5	31.5	24.7	17.2	6.4
1.70V	189.4	146.3	112.8	94.0	79.4	70.8	53.3	43.6	30.9	24.2	17.1	6.4
1.75V	185.8	143.5	110.7	91.0	77.9	69.5	52.3	42.8	30.3	23.9	16.9	6.3
1.80V	181.8	140.5	107.5	87.5	75.9	67.1	50.3	40.9	29.4	23.6	16.7	6.2

Discharge Constant Current per Cell (Amperes at 25°C)

F.V/Time	5min	10min	15min	20min	25min	30min	45min	60min	90min	120min	180min	600min
1.60V	101.5	78.2	60.1	49.9	43.4	36.8	27.2	21.3	15.3	12.2	8.6	3.0
1.67V	99.7	76.8	59.0	49.3	42.6	36.1	26.7	21.1	15.1	12.0	8.5	3.0
1.70V	97.8	75.4	57.9	48.4	41.8	35.4	26.2	20.7	14.8	11.8	8.3	2.9
1.75V	96.0	74.0	56.8	46.8	41.1	34.7	25.7	20.4	14.5	11.6	8.2	2.9
1.80V	94.8	72.8	55.7	45.5	39.5	34.0	25.5	20.0	14.1	11.2	7.9	2.8

Note The above data are average values, and can be obtained within 3 charge/discharge cycles. These are not minimum values. Cell and battery designs/specifications are subject to modification without notice. Contact **CBB** for the latest information.

PERFORMANCE CHARACTERISTICS

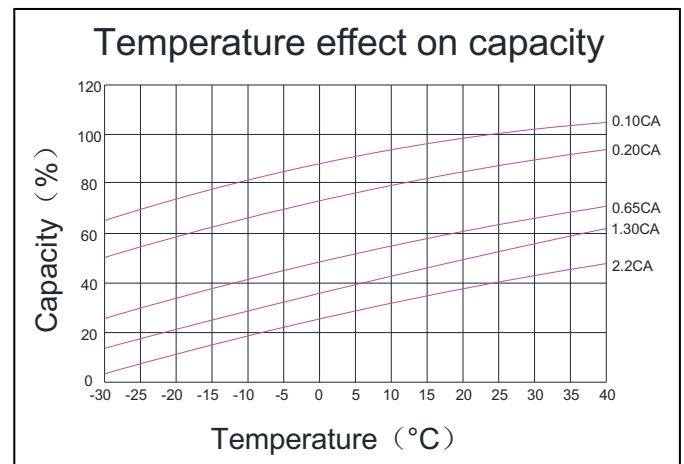
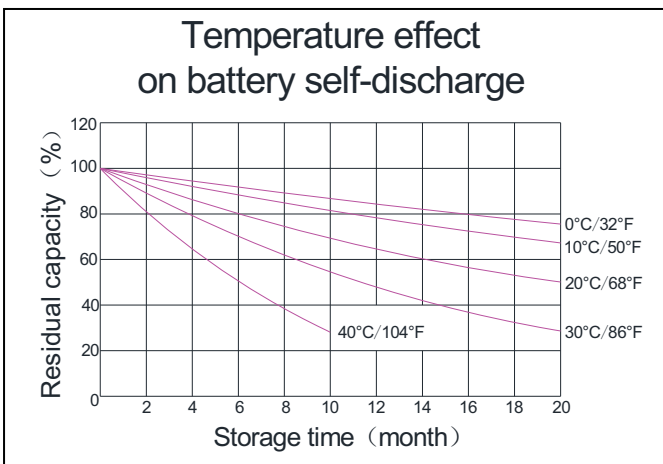
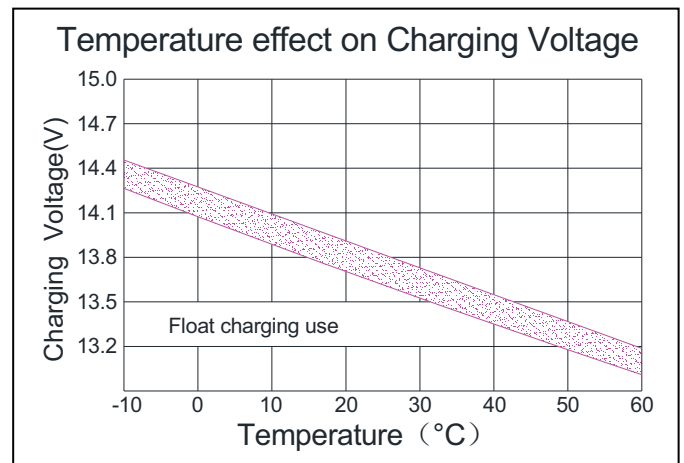
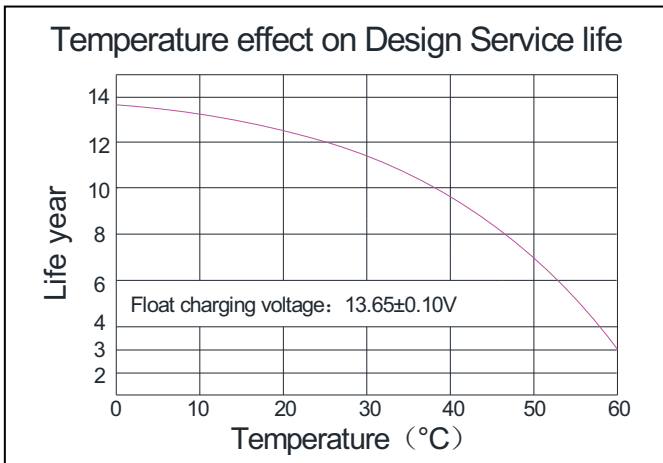
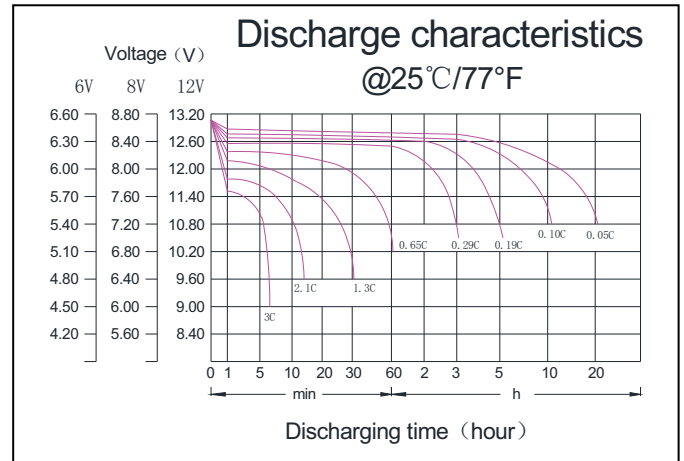
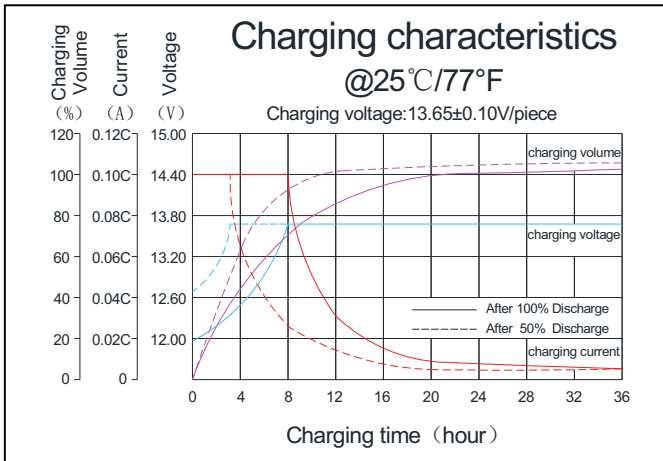

BATTERY CONSTRUCTION

Component	Positive plate	Negative plate	Container & Cover	Safety valve	Terminal	Separator	Electrolyte	Pillar seal
Features	Thick high Sn low Ca grid with special paste	Balanced Pb-Ca grid for improved recombination efficiency	ABS (UL94-V0 optional)	Flame Si-Rubbeand aging resistancer	Female Copper Insert M6(torque:3~4N.m)	Advanced AGM separator for high pressure cell design	Dilute high purity sulphuric acid	Two layers epoxy resin seal

CBB Battery Technology Co.,Ltd.

RM504,55 Hanxing Zhong Road,Zhongcun, Panyu,Guangzhou 511495 China

Tel: +86-020-84888946 Fax: +86-020-62824569

Copyright©2017 CBB Battery Technology Co., Ltd.

Koyama®

www.cbb-battery.com