

EMC TEST REPORT
for

Shenzhen Qinhan Lighting Co., Ltd

LED High Bay Light

Model No: QH-HBGKH-58W, QH-HBGKH-100W, QH-HBGKH-125W,
QH-HBGKH-150W, QH-HBGKH-185W, QH-HBGKH-200W

Prepared for : Shenzhen Qinhan Lighting Co., Ltd

Address : 5/F, Building B, Ideemonto Industrial Park, Shutianpu
Community, Gongming Town, Guangming New District,
Shenzhen City, Guangdong, China

Prepared By : Shenzhen Anbotek Compliance Laboratory Limited
1/F., Building 1, SEC Industrial Park, No.0409 Qianhai Road,
Nanshan District, Shenzhen, Guangdong, China
Tel: (86) 755-26066544
Fax: (86) 755-26014772

Report Number : R0117030017E
Date of Test : Feb. 21~Mar. 06, 2017
Date of Report : Mar. 06, 2017

TABLE OF CONTENTS

Description	Page
Test Report Verification	
1. GENERAL INFORMATION.....	6
1.1. Description of Device (EUT).....	6
1.2. Auxiliary Equipment Used during Test.....	7
1.3. Description of Test Facility.....	7
1.4. Measurement Uncertainty.....	7
1.5. Description of Test Mode.....	8
1.6. Test Summary.....	8
1.7. EMS Performance Criteria.....	9
2. POWER LINE CONDUCTED EMISSION TEST.....	10
2.1. Test Equipment.....	10
2.2. Block Diagram of Test Setup.....	10
2.3. Measuring Standard.....	10
2.4. Power Line Conducted Emission Limits.....	10
2.5. EUT Configuration on Measurement.....	10
2.6. Operating Condition of EUT.....	11
2.7. Test Procedure.....	11
2.8. Measuring Results.....	11
3. RADIATED EMISSION TEST.....	14
3.1. Test Equipment.....	14
3.2. Block Diagram of Test.....	14
3.3. Measuring Standard.....	14
3.4. EUT Configuration on Test.....	15
3.5. Operating Condition of EUT.....	15
3.6. Test Procedure.....	15
3.7. Measuring Results.....	15
4. MAGNETIC RADIATED EMISSION TEST.....	18
4.1. Test Equipment.....	18
4.2. Block Diagram of Test Setup.....	18
4.3. Magnetic Field Emission Measurement Standard and Limits.....	18
4.4. EUT Configuration on Measurement.....	19
4.5. Operating Condition of EUT.....	19
4.6. Test Procedure.....	19
4.7. Measuring Results.....	19
5. HARMONIC CURRENT EMISSION TEST.....	23
5.1. Test Equipment.....	23
5.2. Block Diagram of Test Setup.....	23
5.3. Measuring Standard.....	23
5.4. Operating Condition of EUT.....	23
5.5. Measuring Results.....	23
6. VOLTAGE FLUCTUATIONS & FLICKER TEST.....	25
6.1. Test Equipment.....	25
6.2. Block Diagram of Test Setup.....	25
6.3. Measuring Standard.....	25
6.4. Operating Condition of EUT.....	25

6.5. Measuring Results.....	25
7. ELECTROSTATIC DISCHARGE IMMUNITY TEST.....	27
7.1. Test Equipment.....	27
7.2. Block Diagram of Test Setup.....	27
7.3. Measuring Standard.....	27
7.4. Severity Levels and Performance Criterion.....	27
7.5. EUT Configuration.....	27
7.6. Operating Condition of EUT.....	28
7.7. Test Procedure.....	28
7.8. Measuring Results.....	28
8. RF FIELD STRENGTH SUSCEPTIBILITY TEST.....	30
8.1. Test Equipment.....	30
8.2. Block Diagram of Test Setup.....	30
8.3. Measuring Standard.....	30
8.4. Severity Levels and Performance Criterion.....	31
8.5. EUT Configuration.....	31
8.6. Operating Condition of EUT.....	31
8.7. Test Procedure.....	31
8.8. Measuring Results.....	31
9. ELECTRICAL FAST TRANSIENT/BURST IMMUNITY TEST.....	33
9.1. Test Equipment.....	33
9.2. Block Diagram of Test Setup.....	33
9.3. Measuring Standard.....	33
9.4. Severity Levels and Performance Criterion.....	33
9.5. EUT Configuration.....	34
9.6. Operating Condition of EUT.....	34
9.7. Test Procedure.....	34
9.8. Measuring Results.....	34
10. SURGE IMMUNITY TEST.....	36
10.1. Test Equipment.....	36
10.2. Block Diagram of Test Setup.....	36
10.3. Measuring Standard.....	36
10.4. Severity Levels and Performance Criterion.....	36
10.5. EUT Configuration.....	36
10.6. Operating Condition of EUT.....	37
10.7. Test Procedure.....	37
10.8. Measuring Results.....	37
11. INJECTED CURRENTS SUSCEPTIBILITY TEST.....	39
11.1. Test Equipment.....	39
11.2. Block Diagram of Test Setup.....	39
11.3. Measuring Standard.....	39
11.4. Severity Levels and Performance Criterion.....	39
11.5. EUT Configuration.....	39
11.6. Operating Condition of EUT.....	40
11.7. Test Procedure.....	40
11.8. Measuring Results.....	40
12. VOLTAGE DIPS AND INTERRUPTIONS TEST.....	42
12.1. Test Equipment.....	42
12.2. Block Diagram of Test Setup.....	42
12.3. Measuring Standard.....	42
12.4. Severity Levels and Performance Criterion.....	42
12.5. EUT Configuration.....	42

12.6. Operating Condition of EUT.....	43
12.7. Test Procedure.....	43
12.8. Measuring Results.....	43
13. PHOTOGRAPHS.....	45
13.1. Photo of Power Line Conducted Emission Test.....	45
13.2. Photo of Radiated Emission Test.....	45
13.3. Photo of Magnetic Radiated Emission Test.....	46
13.4. Photo of Flicker/ Harmonic Test.....	46
13.5. Photo of Electrostatic Discharge Immunity Test.....	47
13.6. Photo of RF Field Strength susceptibility Test.....	47
13.7. Photo of Electrical Fast Transient/Burst Immunity Test.....	48
13.8. Photo of Surge Immunity Test.....	48
13.9. Photo of Injected currents susceptibility Test.....	49
13.10. Photo of Voltage Dips and Interruptions Test.....	49

APPENDIX I (Photos of EUT) (4 pages)

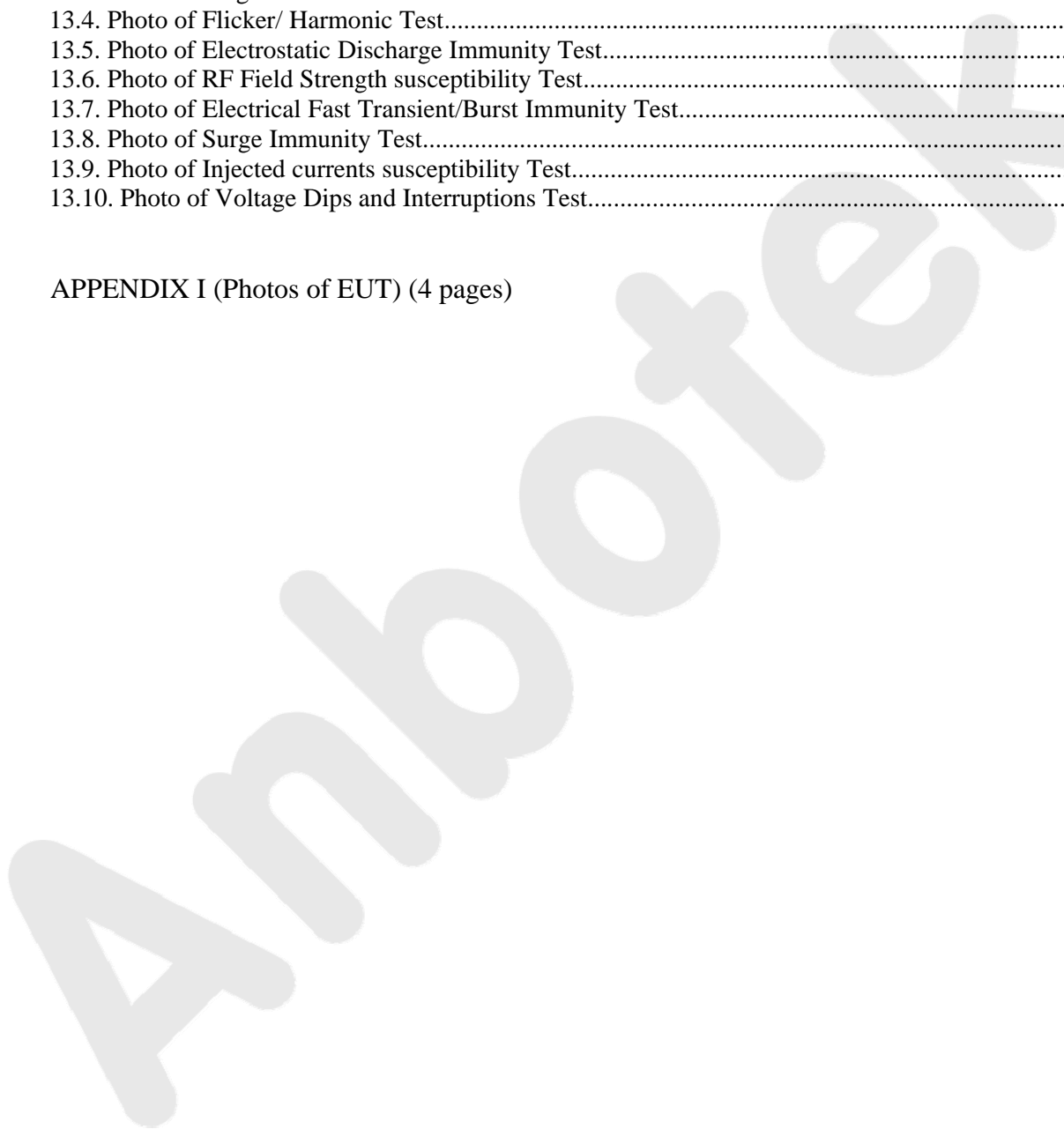

TEST REPORT VERIFICATION

Applicant : Shenzhen Qinhan Lighting Co., Ltd
Manufacturer : Shenzhen Qinhan Lighting Co., Ltd
EUT : LED High Bay Light
Rating : 100-277V~, 50-60Hz,
QH-HBGKH-58W(58W), QH-HBGKH-100W(100W),
QH-HBGKH-125W(125W), QH-HBGKH-150W(150W),
QH-HBGKH-185W(185W), QH-HBGKH-200W(200W)

Trade Mark : 

Measurement Procedure Used:
EN 55015: 2013+A1: 2015
EN 61000-3-2: 2014
EN 61000-3-3: 2013
EN 61547: 2009
(IEC 61000-4-2; IEC 61000-4-3; IEC 61000-4-4;
IEC 61000-4-5; IEC 61000-4-6; IEC 61000-4-11)

The device described above is tested by Shenzhen Anbotek Compliance Laboratory Limited to determine the maximum emission levels emanating from the device and the severe levels of the device can endure and its performance criterion. The measurement results are contained in this test report and Shenzhen Anbotek Compliance Laboratory Limited is assumed full responsibility for the accuracy and completeness of these measurements. Also, this report shows that the EUT to be technically compliant with the EN 55015, EN 61000-3-2, EN 61000-3-3 and EN 61547 requirements. The Project in IEC 61000-4-3 was tested in Shenzhen EMTEK Co., Ltd.

This report applies to above tested sample only and shall not be reproduced in part without written approval of Shenzhen Anbotek Compliance Laboratory Limited.

Date of Test : Feb. 21~Mar. 06, 2017

Prepared by : 
(Engineer/ Baron Wen)

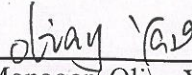
Reviewer : 
(Project Manager/ Ollay Yang)

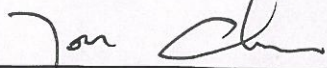
Approved & Authorized Signer : 
(Manager/ Tom Chen)

1. GENERAL INFORMATION

1.1. Description of Device (EUT)

EUT	: LED High Bay Light
Model Number	: QH-HBGKH-58W, QH-HBGKH-100W, QH-HBGKH-125W, QH-HBGKH-150W, QH-HBGKH-185W, QH-HBGKH-200W (Note: All samples are the same except the model number & appearance, so we prepare “QH-HBGKH-200W” for EMC test only.)
Test Power Supply	: AC 230V, 50Hz
Applicant	: Shenzhen Qinhan Lighting Co., Ltd
Address	: 5/F, Building B, Ideemonto Industrial Park, Shutianpu Community, Gongming Town, Guangming New District, Shenzhen City, Guangdong, China
Manufacturer	: Shenzhen Qinhan Lighting Co., Ltd
Address	: 5/F, Building B, Ideemonto Industrial Park, Shutianpu Community, Gongming Town, Guangming New District, Shenzhen City, Guangdong, China
Factory	: Shenzhen Qinhan Lighting Co., Ltd
Address	: 5/F, Building B, Ideemonto Industrial Park, Shutianpu Community, Gongming Town, Guangming New District, Shenzhen City, Guangdong, China

1.2. Auxiliary Equipment Used during Test

N/A

1.3. Description of Test Facility

The test facility is recognized, certified, or accredited by the following organizations:

FCC-Registration No.: 752021

Shenzhen Anbotek Compliance Laboratory Limited, EMC Laboratory has been registered and fully described in a report filed with the (FCC) Federal Communications Commission. The acceptance letter from the FCC is maintained in our files. Registration 752021, July 06, 2016.

IC-Registration No.: 8058A-1

Shenzhen Anbotek Compliance Laboratory Limited, EMC Laboratory has been registered and fully described in a report filed with the (IC) Industry Canada. The acceptance letter from the IC is maintained in our files. Registration 8058A-1, June 13, 2016.

CNAS – LAB Code: L3503

Shenzhen Anbotek Compliance Laboratory Limited., Laboratory has been assessed and in compliance with CNAS/CL01: 2006 accreditation criteria for testing laboratories (identical to ISO/IEC 17025: 2005 General Requirements) for the Competence of Testing Laboratories.

Test Location

All Emissions tests were performed

Shenzhen Anbotek Compliance Laboratory Limited. At 1/F., Building 1, SEC Industrial Park, No.0409 Qianhai Road, Nanshan District, Shenzhen, Guangdong, China

1.4. Measurement Uncertainty

Radiation Uncertainty	:	Ur = 4.1dB (Horizontal) Ur = 4.3dB (Vertical)
Conduction Uncertainty	:	Uc = 3.4dB
Magnetic Uncertainty	:	Um = 3.3dB

1.5. Description of Test Mode

Pretest Mode	Description
Mode 1	On

For Mode 1 Block Diagram of Test Setup

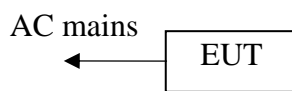

1.6. Test Summary

Test Items	Test Mode	Status
Power Line Conducted Emission Test (9KHz To 30MHz)	Mode 1	P
Radiated Emission Test(30MHz To 300MHz)	Mode 1	P
Magnetic Radiated Emission Test(9KHz To 30MHz)	Mode 1	P
Harmonic Current Test	Mode 1	P
Voltage Fluctuations and Flicker Test	Mode 1	P
Electrostatic Discharge immunity Test	Mode 1	P
RF Field Strength susceptibility Test	Mode 1	P
Electrical Fast Transient/Burst Immunity Test	Mode 1	P
Surge Immunity Test	Mode 1	P
Injected Currents Susceptibility Test	Mode 1	P
Voltage Dips and Interruptions Test	Mode 1	P

P) Indicates that the through the test.

N) Don't test.

1.7. EMS Performance Criteria

- √ A: Normal performance within the specification limits
- √ B: Temporary degradation or loss of function or performance which is self-recoverable
- √ C: Temporary degradation or loss of function or performance which requires operator intervention or system reset
- √ D: Degradation or loss of function which is not recoverable due to damage of equipment (components) or software, or loss of data

Note: The manufacturer's specification may define effects on the EUT which may be considered insignificant, and therefore acceptable.

This classification may be used as a guide in formulating performance criteria, by committees responsible for generic, product and product-family standards, or as a framework for the agreement on performance criteria between the manufacturer and the purchaser, for example where no suitable generic, product or product-family standard exists.

2. POWER LINE CONDUCTED EMISSION TEST

2.1. Test Equipment

The following test equipments are used during the power line conducted measurement:

Item	Equipment	Manufacturer	Model No.	Serial No.	Last Cal.	Cal. Interval
1.	Two-Line V-network	Rohde & Schwarz	ENV216	100055	Jul. 19, 2016	1 Year
2.	EMI Test Receiver	Rohde & Schwarz	ESCI	100627	Jun. 17, 2016	1 Year
3.	RF Switching Unit	Compliance Direction	RSU-M2	38303	Jun. 17, 2016	1 Year

2.2. Block Diagram of Test Setup

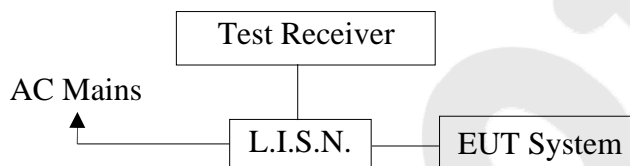

2.3. Measuring Standard

EN 55015

2.4. Power Line Conducted Emission Limits

Frequency	At mains terminals (dB μ V)	
	Quasi-peak Level	Average Level
9KHz ~ 50KHz	110	--
50KHz ~ 150KHz	90 ~ 80*	--
150KHz ~ 0.5MHz	66 ~ 56*	56 ~ 46*
0.5MHz ~ 5.0MHz	56	46
5.0MHz ~ 30MHz	60	50

1. At the transition frequency the lower limit applies.
2. * decreasing linearly with logarithm of the frequency.

2.5. EUT Configuration on Measurement

The following equipments are installed on Conducted Emission Measurement to meet EN 55015 requirements and operating in a manner which tends to maximize its emission characteristics in a normal application.

2.6. Operating Condition of EUT

- 2.6.1. Setup the EUT as shown in Section 2.2.
- 2.6.2. Turn on the power of all equipments.
- 2.6.3. Let the EUT work in test mode and measure it.

2.7. Test Procedure

The EUT is put on the table which is 0.8 meter high above the ground and connected to the AC mains through a Line Impedance Stabilization Network (L.I.S.N.). This provided a 50ohm coupling impedance for the tested equipments. Both sides of AC line are checked to find out the maximum conducted emission according to the EN 55015 regulations during conducted emission measurement. And the voltage probe had been used for the load terminals measurement according to the EN 55015 standard.

The bandwidth of the test receiver (R&S ESCI) is set at 200Hz in 9K~150KHz range and 9KHz in 150K~30MHz range.

The frequency range from 9KHz to 30MHz is checked.

All the test results are listed in Section 2.8.

2.8. Measuring Results

PASS

The frequency range 9KHz to 30MHz is investigated.

The test curves are shown in the following pages.

CONDUCTED EMISSION TEST DATA

Test Site: 1# Shielded Room
 Test Specification: AC 230V, 50Hz
 Comment: L
 Temp.: 22.2°C Hum.: 60%

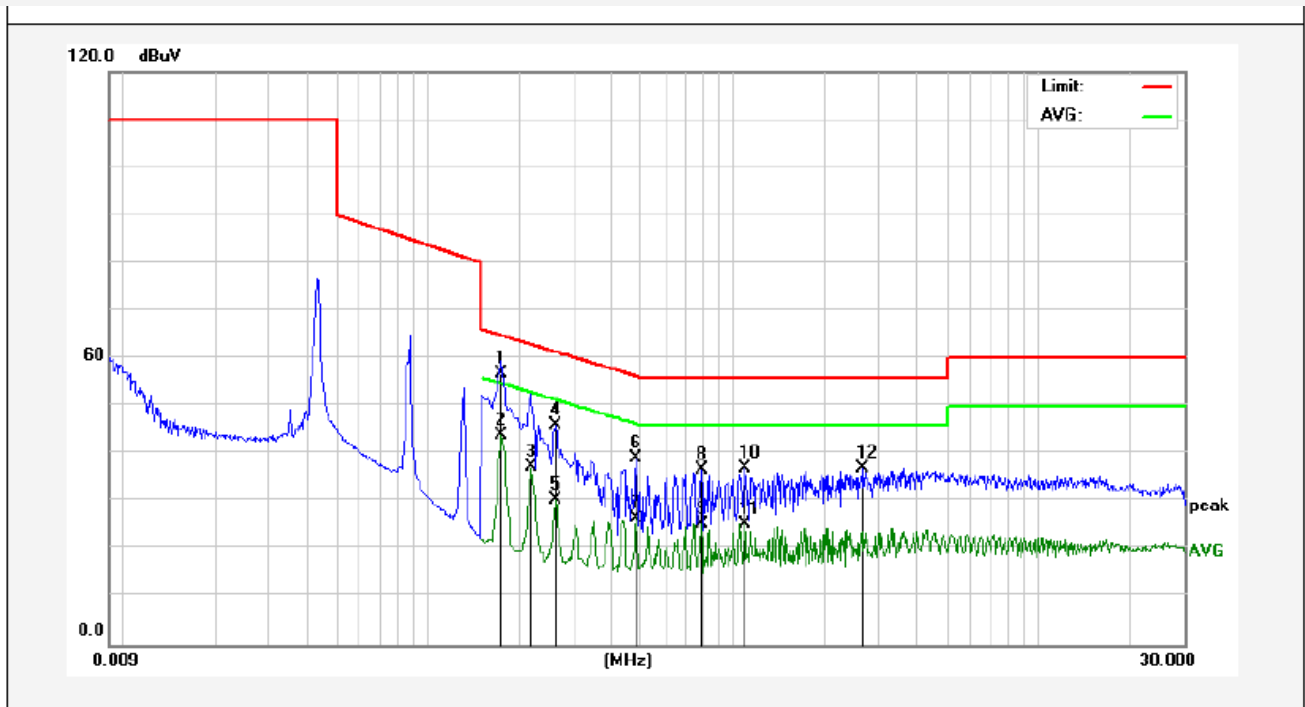

No.	Freq. (MHz)	Reading (dBuV)	Factor (dB)	Result (dBuV)	Limit dBuV	Over Limit (dB)	Detector	Remark
1	0.1740	36.95	19.90	56.85	64.76	-7.91	QP	
2	0.1740	23.92	19.90	43.82	54.76	-10.94	AVG	
3	0.2180	17.30	19.90	37.20	52.89	-15.69	AVG	
4	0.2620	26.21	19.89	46.10	61.36	-15.26	QP	
5	0.2620	10.57	19.89	30.46	51.36	-20.90	AVG	
6	0.4820	19.16	19.97	39.13	56.30	-17.17	QP	
7	0.4820	6.73	19.97	26.70	46.30	-19.60	AVG	
8	0.7900	16.62	20.06	36.68	56.00	-19.32	QP	
9	0.7900	5.43	20.06	25.49	46.00	-20.51	AVG	
10	1.0940	16.83	20.12	36.95	56.00	-19.05	QP	
11	1.0940	5.25	20.12	25.37	46.00	-20.63	AVG	
12	2.6740	16.96	20.15	37.11	56.00	-18.89	QP	

CONDUCTED EMISSION TEST DATA

Test Site: 1# Shielded Room
 Test Specification: AC 230V, 50Hz
 Comment: N
 Temp.: 22.2°C Hum.: 60%

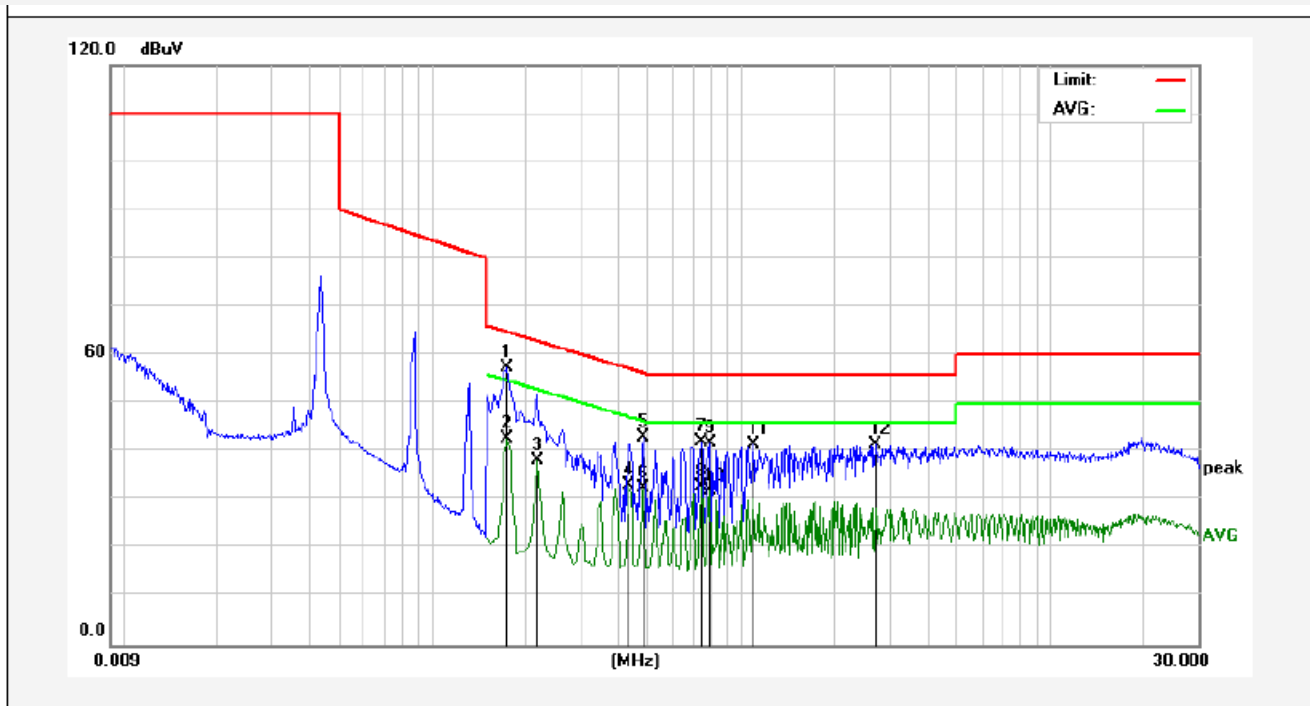

No.	Freq. (MHz)	Reading (dBuV)	Factor (dB)	Result (dBuV)	Limit dBuV	Over Limit (dB)	Detector	Remark
1	0.1740	37.69	19.90	57.59	64.76	-7.17	QP	
2	0.1740	22.91	19.90	42.81	54.76	-11.95	AVG	
3	0.2180	18.39	19.90	38.29	52.89	-14.60	AVG	
4	0.4340	13.12	19.95	33.07	47.18	-14.11	AVG	
5	0.4820	23.19	19.97	43.16	56.30	-13.14	QP	
6	0.4820	12.62	19.97	32.59	46.30	-13.71	AVG	
7	0.7420	22.13	20.05	42.18	56.00	-13.82	QP	
8	0.7420	12.72	20.05	32.77	46.00	-13.23	AVG	
9	0.7860	21.82	20.06	41.88	56.00	-14.12	QP	
10	0.7860	11.91	20.06	31.97	46.00	-14.03	AVG	
11	1.0900	21.30	20.12	41.42	56.00	-14.58	QP	
12	2.7100	21.31	20.15	41.46	56.00	-14.54	QP	

3. RADIATED EMISSION TEST

3.1. Test Equipment

The following test equipments are used during radiated emission measurement:

Item	Equipment	Manufacturer	Model No.	Serial No.	Last Cal.	Cal. Interval
1.	EMI Test Receiver	Rohde & Schwarz	ESPI	101604	Jun. 17, 2016	1 Year
2.	Bilog Broadband Antenna	Schwarzbeck	VULB9163	VULB 9163-289	May 06, 2016	1 Year
3.	Pre-amplifier	SONOMA	310N	186860	Jun. 17, 2016	1 Year

3.2. Block Diagram of Test

3.2.1. Block diagram of test setup in chamber

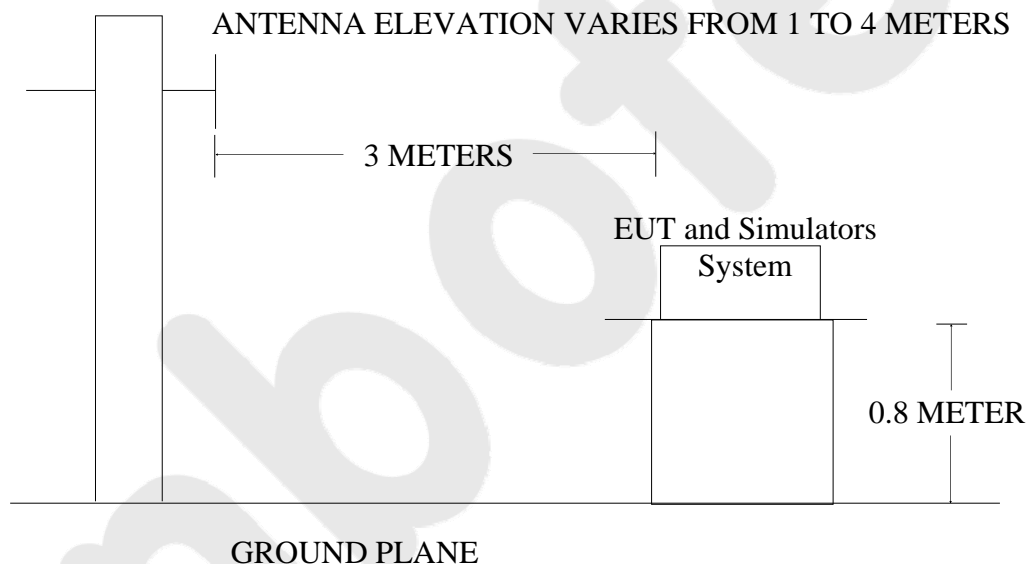

3.3. Measuring Standard

EN 55015

Radiated Emission Limits

All emanations from an EN 55015 device or system, including any network of conductors and apparatus connected thereto, shall not exceed the level of field strengths specified below:

FREQUENCY (MHz)	DISTANCE (Meters)	FIELD STRENGTHS LIMIT (dB μ V/m)
30 ~ 230	3	40
230 ~ 300	3	47

- Note:
- (1) The smaller limit shall apply at the combination point between two frequency bands.
 - (2) Distance refers to the distance in meters between the measuring instrument antenna and the closed point of any part of the EUT.

3.4. EUT Configuration on Test

The EN 55015 regulations test method must be used to find the maximum emission during radiated emission measurement.

3.5. Operating Condition of EUT

3.5.1. Setup the EUT as shown in Section 3.2.

3.5.2. Turn on the power of all equipments.

3.5.3. Let the EUT work in test mode and measure it.

3.6. Test Procedure

The EUT is placed on a turn table which is 0.8 meter high above the ground. The turn table can rotate 360 degrees to determine the position of the maximum emission level. The EUT is set 3 meters away from the receiving antenna which is mounted on an antenna tower. The antenna can be moved up and down from 1 to 4 meters to find out the maximum emission level. Bilog antenna is used as a receiving antenna. Both horizontal and vertical polarization of the antenna are set on test.

The bandwidth of the Receiver (ESCI) is set at 120kHz.

The EUT is tested in Chamber.

The test results are listed in Section 3.7.

3.7. Measuring Results

PASS

The frequency range from 30MHz to 300MHz is investigated.

The test curves are shown in the following pages.

Test item: Radiation Test **Polarization:** Horizontal
Standard: (RE)EN55015 **Power Source:** AC 230V, 50Hz
Distance: 3m **Temp.(°C)/Hum.(%RH):** 24.3(°C)/55%RH
Note:

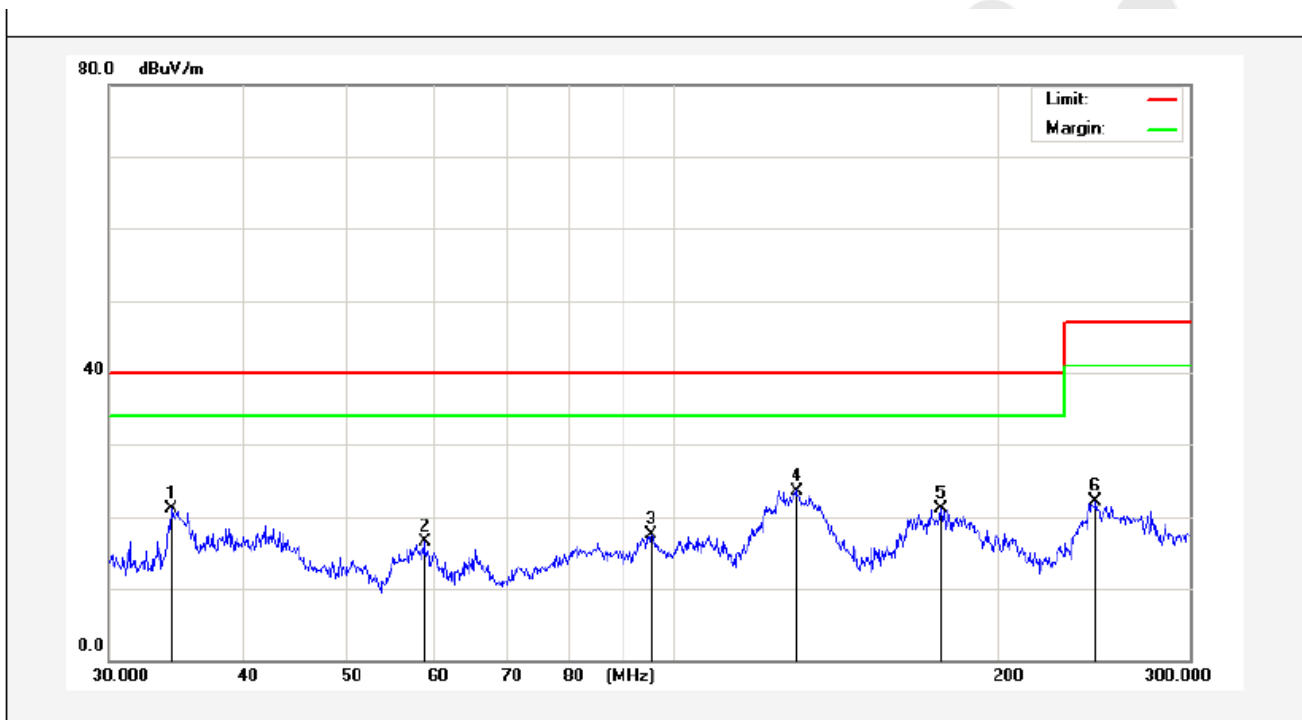

No.	Freq. (MHz)	Reading (dBuV/m)	Factor (dB/m)	Result (dBuV/m)	Limit (dBuV/)	Over Limit (dB)	Detector	Height (cm)	degree (deg)	Remark
1	34.2863	35.85	-14.67	21.18	40.00	-18.82	peak			
2	58.7653	31.77	-15.29	16.48	40.00	-23.52	peak			
3	95.3062	38.59	-21.00	17.59	40.00	-22.41	peak			
4	129.7541	46.37	-22.77	23.60	40.00	-16.40	peak			
5	176.6531	43.29	-22.09	21.20	40.00	-18.80	peak			
6	245.5394	40.52	-18.34	22.18	47.00	-24.82	peak			

Test item:	Radiation Test	Polarization:	Vertical
Standard:	(RE)EN55015	Power Source:	AC 230V, 50Hz
Distance:	3m	Temp.(°C)/Hum.(%RH):	24.3(°C)/55%RH
Note:			

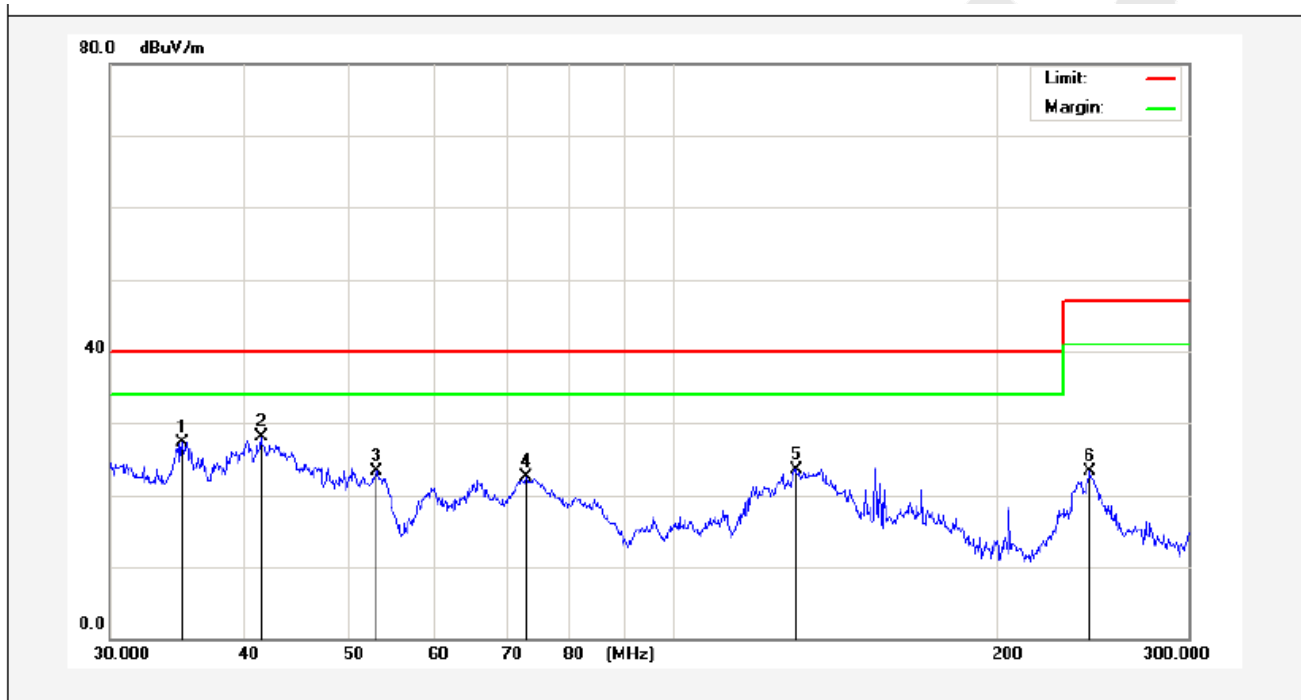

No.	Freq. (MHz)	Reading (dBuV/m)	Factor (dB/m)	Result (dBuV/m)	Limit (dBuV/)	Over Limit (dB)	Detector	Height (cm)	degree (deg)	Remark
1	35.0042	41.57	-14.29	27.28	40.00	-12.72	peak			
2	41.4115	39.03	-10.92	28.11	40.00	-11.89	peak			
3	52.9811	38.13	-14.78	23.35	40.00	-16.65	peak			
4	72.9661	42.76	-20.20	22.56	40.00	-17.44	peak			
5	129.7541	41.28	-17.77	23.51	40.00	-16.49	peak			
6	243.2883	37.33	-14.08	23.25	47.00	-23.75	peak			

4. MAGNETIC RADIATED EMISSION TEST

4.1. Test Equipment

The following test equipments are used during the Magnetic Radiated emission measurement:

Item	Equipment	Manufacturer	Model No.	Serial No.	Last Cal.	Cal. Interval
1.	EMI Test Receiver	Rohde & Schwarz	ESCI	100627	Jun. 17, 2016	1 Year
2.	Triple-Loop Antenna(2M)	EVERFINE	LLA-2	905003	Apr. 16, 2016	1 Year
3.	RF Switching Unit	Compliance Direction	RSU-M2	38303	Jun. 17, 2016	1 Year

4.2. Block Diagram of Test Setup

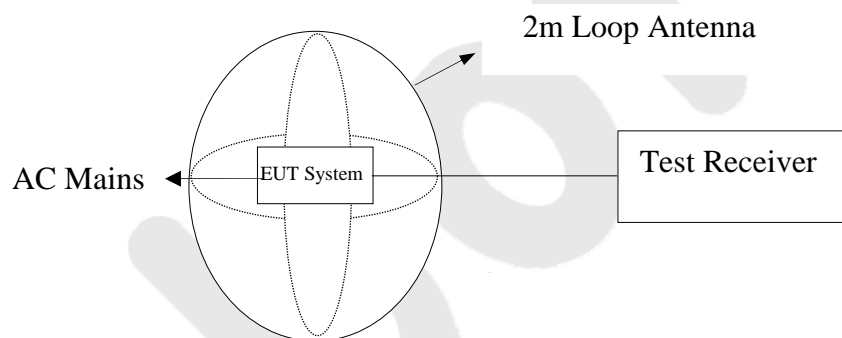

4.3. Magnetic Field Emission Measurement Standard and Limits

4.3.1. Measuring Standard

EN 55015

4.3.2. Measuring Limits

Frequency	Limits for loop diameter (dB μ A)
	2m
9KHz ~ 70KHz	88
70KHz ~ 150KHz	88 ~ 58*
150KHz ~ 3.0MHz	58 ~ 22*
3.0MHz ~ 30MHz	22

1. At the transition frequency the lower limit applies.
2. * decreasing linearly with logarithm of the frequency.

4.4. EUT Configuration on Measurement

The following equipments are installed on Magnetic Radiated emission Measurement to meet EN 55015 requirements and operating in a manner which tends to maximize its emission characteristics in a normal application.

4.5. Operating Condition of EUT

- 4.5.1. Setup the EUT as shown in Section 4.2.
- 4.5.2. Turn on the power of all equipments.
- 4.5.3. Let the EUT work in test mode and measure it.

4.6. Test Procedure

The EUT is placed on a wood table in the center of a loop antenna. The induced current in the loop antenna is measured by means of a current probe and the test receiver. Three field components are checked by means of a coaxial switch.

The frequency range from 9KHz to 30MHz is investigated. The receiver is measured with the quasi-peak detector. For frequency band 9KHz to 150KHz, the bandwidth of the test receiver (ESCI) is set at 200Hz. For frequency band 150KHz to 30MHz, the bandwidth is set at 9KHz.

All the test results are listed in Section 4.7.

4.7. Measuring Results

PASS

The frequency range from 9KHz to 30MHz is investigated.

The test curves are shown in the following pages.

MAGNETIC RADIATED EMISSION TEST

Test Site: 1# Shielded Room
 Test Specification: AC 230V, 50Hz
 Comment: X
 Temp.: 22.2°C Hum.: 59%

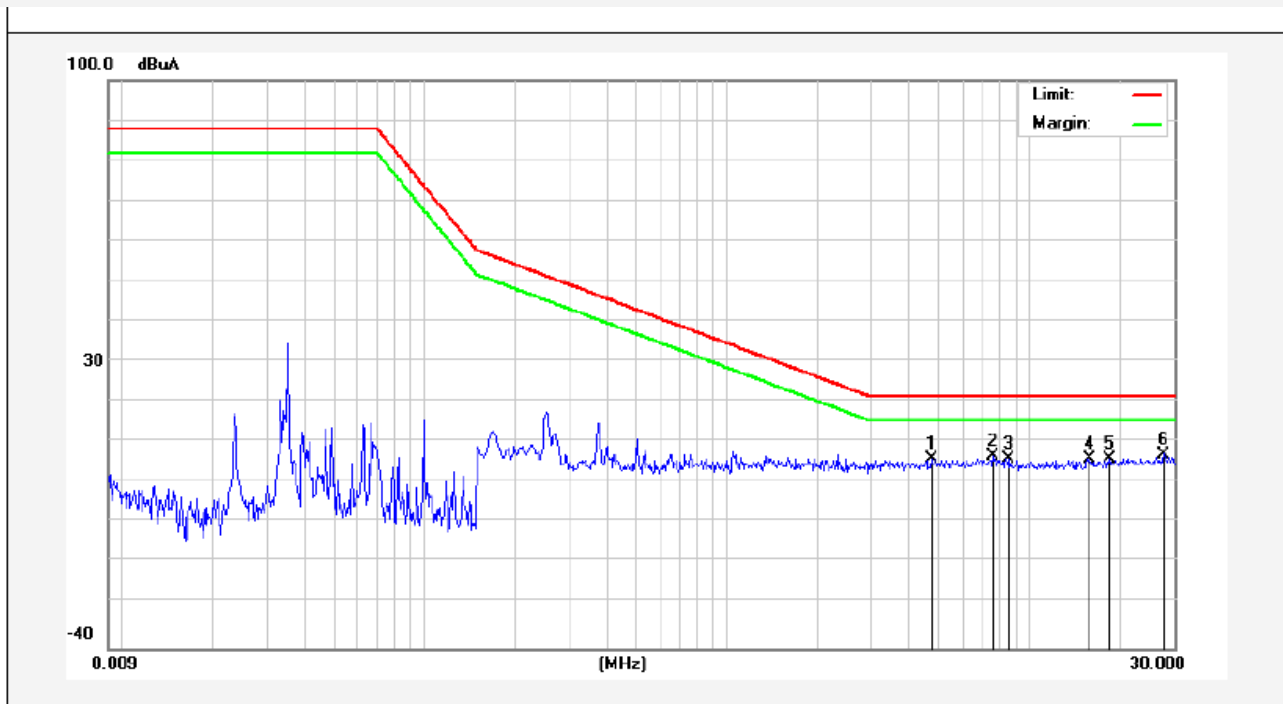

No.	Freq. (MHz)	Reading (dBuA)	Factor (dB)	Result (dBuA)	Limit dBuA	Over Limit (dB)	Detector	Remark
1	4.7300	6.82	0.00	6.82	22.00	-15.18	QP	
2	7.5580	7.56	0.00	7.56	22.00	-14.44	QP	
3	8.5740	6.58	0.00	6.58	22.00	-15.42	QP	
4	15.7380	6.68	0.00	6.68	22.00	-15.32	QP	
5	18.4220	6.87	0.00	6.87	22.00	-15.13	QP	
6	27.7460	7.95	0.00	7.95	22.00	-14.05	QP	

MAGNETIC RADIATED EMISSION TEST

Test Site: 1# Shielded Room
 Test Specification: AC 230V, 50Hz
 Comment: Y
 Temp.: 22.2°C Hum.: 59%

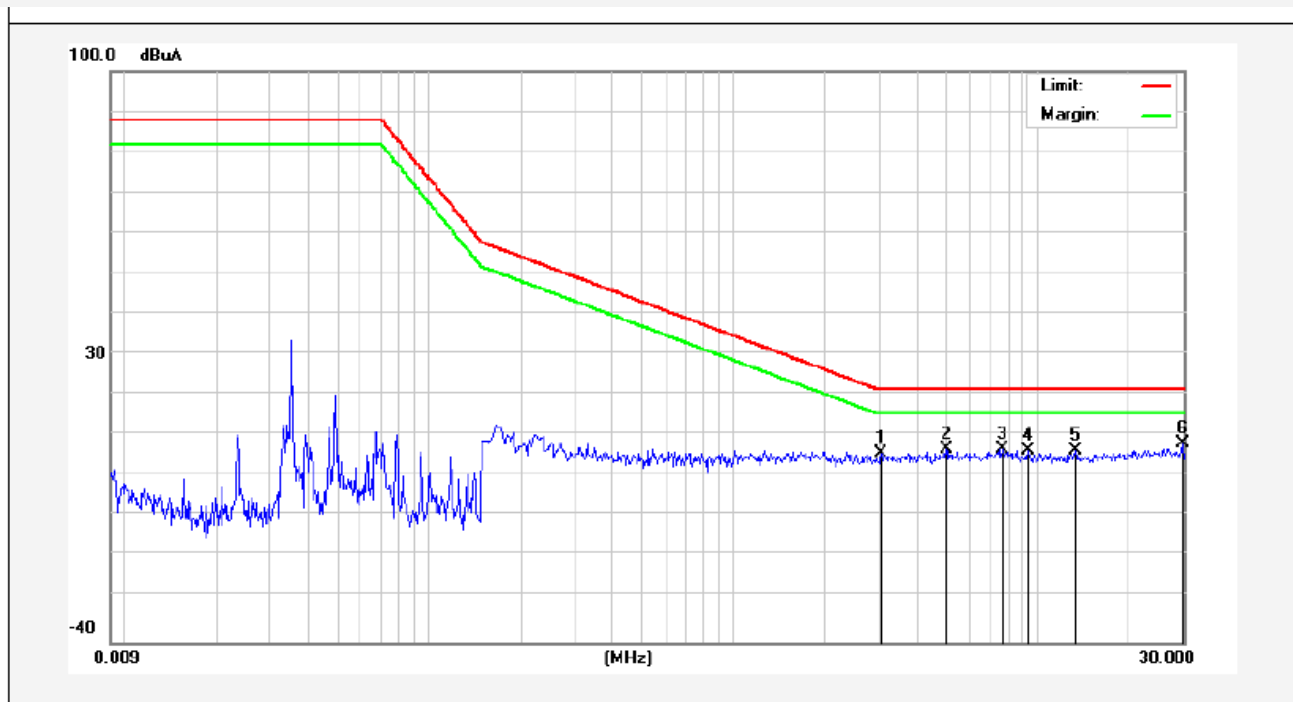

No.	Freq. (MHz)	Reading (dBuA)	Factor (dB)	Result (dBuA)	Limit dBuA	Over Limit (dB)	Detector	Remark
1	3.0579	6.54	0.00	6.54	22.00	-15.46	QP	
2	5.0300	7.56	0.00	7.56	22.00	-14.44	QP	
3	7.6540	7.51	0.00	7.51	22.00	-14.49	QP	
4	9.3100	6.91	0.00	6.91	22.00	-15.09	QP	
5	13.2820	7.04	0.00	7.04	22.00	-14.96	QP	
6	29.7940	8.69	0.00	8.69	22.00	-13.31	QP	

MAGNETIC RADIATED EMISSION TEST

Test Site: 1# Shielded Room
 Test Specification: AC 230V, 50Hz
 Comment: Z
 Temp.: 22.2°C Hum.: 59%

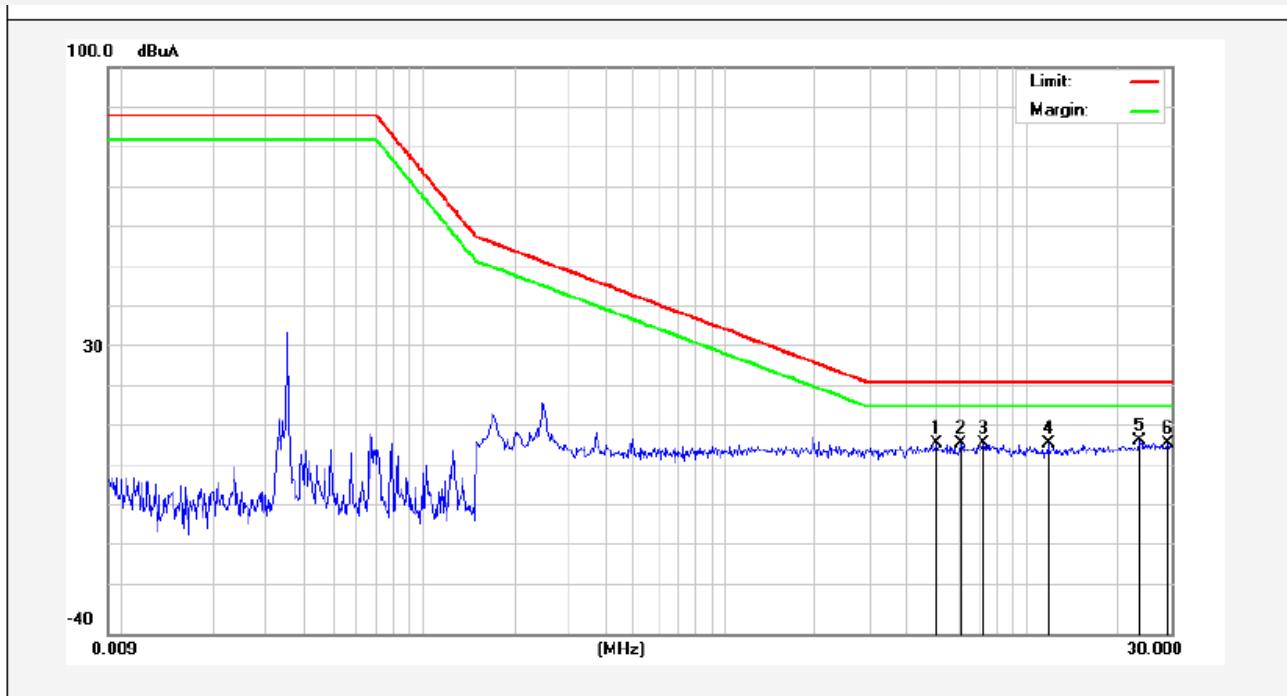

No.	Freq. (MHz)	Reading (dBuA)	Factor (dB)	Result (dBuA)	Limit dBuA	Over Limit (dB)	Detector	Remark
1	5.0140	7.00	0.00	7.00	22.00	-15.00	QP	
2	6.0340	7.02	0.00	7.02	22.00	-14.98	QP	
3	7.1820	7.08	0.00	7.08	22.00	-14.92	QP	
4	11.7299	6.91	0.00	6.91	22.00	-15.09	QP	
5	23.5580	7.78	0.00	7.78	22.00	-14.22	QP	
6	29.1060	7.23	0.00	7.23	22.00	-14.77	QP	

5. HARMONIC CURRENT EMISSION TEST

5.1. Test Equipment

The following test equipments are used during harmonic current emission measurement:

Item	Equipment	Manufacturer	Model No.	Serial No.	Last Cal.	Cal. Interval
1.	Programmable AC Power source	SOPH POWER	PAG-1050	630250	Jun. 17, 2016	1 Year
2.	Harmonic and Flicker Analyzer	LAPLACE	AC-2000A	272629	Apr. 16, 2016	1 Year

5.2. Block Diagram of Test Setup

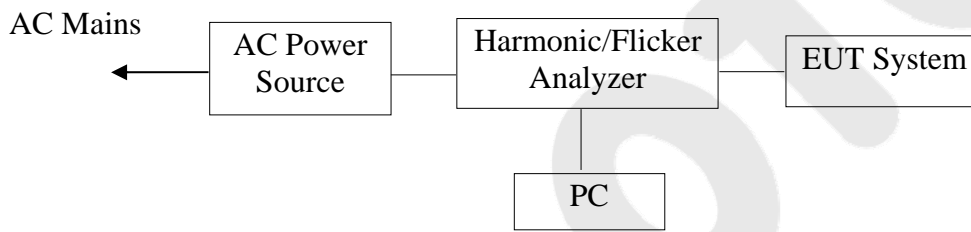

5.3. Measuring Standard

EN 61000-3-2

5.4. Operating Condition of EUT

- 5.4.1. Setup the EUT as shown on Section 5.2.
- 5.4.2. Turn on the power of all equipments.
- 5.4.3. After that, let the EUT work in test mode measure it.

5.5. Measuring Results

PASS

The test curves are shown in the following pages.

Harmonic Current Test Result Summary (Run time)

Tested On : Feb. 21, 2017 08:52 for 150 Seconds.

Supply Voltage : 228.7 Vrms 322.8 Vpk Frequency : 50.00 Hz

Supply Pass : Harmonic Requirements.

Load Power : 163.48 to 163.87 W 170.88 VA Power Factor 0.957

Load Current : 747.0 to 748.9 mArms 1176.6 to 1187.6 mApk Crest Factor: 1.577

Limits Applied : EN61000-3-2: 2014 Class C Limits >25W for 10.000A at 0.900 PF.

Harmonic Number	Limit Current mA	Average (filtered) mA	% Limit	max. Value (Filtered) mA	% Limit	Assessment
Fundamental :		736.9				
2 :	200.0	1.8	0.9	1.8	0.9	Pass
3 :	2700.2	112.3	4.2	112.3	4.2	Pass
4 :	-	1.0	-	1.1	-	-
5 :	1000.0	26.8	2.7	26.9	2.7	Pass
6 :	-	0.7	-	0.8	-	-
7 :	700.0	23.6	3.4	23.6	3.4	Pass
8 :	-	0.6	-	0.6	-	-
9 :	500.0	20.3	4.1	20.3	4.1	Pass
10 :	-	0.6	-	0.6	-	-
11 :	300.0	12.9	4.3	12.9	4.3	Pass
12 :	-	0.6	-	0.6	-	-
13 :	300.0	9.8	3.3	9.8	3.3	Pass
14 :	-	0.6	-	0.6	-	-
15 :	300.0	4.3	1.4	4.3	1.4	Pass
16 :	-	0.8	-	0.8	-	-
17 :	300.0	4.4	1.5	4.5	1.5	Pass
18 :	-	0.6	-	0.6	-	-
19 :	300.0	3.5	1.2	3.5	1.2	Pass
20 :	-	0.7	-	0.7	-	-
21 :	300.0	4.2	1.4	4.3	1.4	Pass
22 :	-	0.7	-	0.7	-	-
23 :	300.0	7.1	2.4	7.1	2.4	Pass
24 :	-	0.7	-	0.7	-	-
25 :	300.0	4.1	1.4	4.1	1.4	Pass
26 :	-	0.8	-	0.8	-	-
27 :	300.0	0.8	0.3	0.8	0.3	Pass
28 :	-	0.8	-	0.8	-	-
29 :	300.0	1.4	0.5	1.4	0.5	Pass
30 :	-	0.9	-	0.9	-	-
31 :	300.0	2.6	0.9	2.6	0.9	Pass
32 :	-	0.8	-	0.8	-	-
33 :	300.0	1.7	0.6	1.8	0.6	Pass
34 :	-	0.8	-	0.8	-	-
35 :	300.0	2.7	0.9	2.8	0.9	Pass
36 :	-	0.8	-	0.8	-	-
37 :	300.0	2.1	0.7	2.2	0.7	Pass
38 :	-	0.8	-	0.8	-	-
39 :	300.0	1.5	0.5	1.5	0.5	Pass
40 :	-	0.7	-	0.7	-	-
21 - 39 :	948.7	10.6	1.1	10.6	1.1	-

6. VOLTAGE FLUCTUATIONS & FLICKER TEST

6.1. Test Equipment

The following test equipments are used during the voltage fluctuations and flicker measurement:

Item	Equipment	Manufacturer	Model No.	Serial No.	Last Cal.	Cal. Interval
1.	Programmable AC Power source	SOPH POWER	PAG-1050	630250	Jun. 17, 2016	1 Year
2.	Harmonic and Flicker Analyzer	LAPLACE	AC-2000A	272629	Apr. 16, 2016	1 Year

6.2. Block Diagram of Test Setup

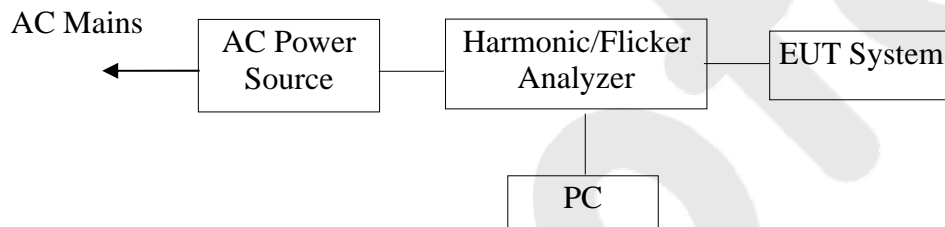

6.3. Measuring Standard

EN 61000-3-3

6.4. Operating Condition of EUT

- 6.4.1. Setup the EUT as shown on Section 6.2.
- 6.4.2. Turn on the power of all equipments.
- 6.4.3. After that, let the EUT work in test mode measure it.

6.5. Measuring Results

PASS

The test curves are shown in the following pages.

Flicker Test Summary per EN/IEC61000-3-3 (Run time)

Tested On : Feb. 21, 2017 08:50 for 600 Seconds.

Supply Voltage : 228.6 to 228.8 Vrms 322.6 Vpk Frequency : 50.00 Hz
Load Current : 748.8 to 749.9 mArms 1171.0 to 1176.1 mApk Crest Factor: 1.568

Test Method: EN61000-3-3: 2013

Voltage Variations :

Highest Level:	-0.47%	
Lowest Level:	-0.68%	
d(max):	0.21%	PASS
Highest d(t) of 500ms:	0.00%	PASS
Present d(t) over 3.33%:	0.00 Seconds	
Longest d(t) over 3.33%:	0.00 Seconds	
Highest Steady State:	-0.59%	
Lowest Steady State:	-0.59%	
Max d(c) Between Adjacent:	0.00%	PASS
Max d(c) Between Any:	0.00%	
Short Term Flicker Pst:	0.61	PASS

Flicker Results :

Pst Classifier	Plt Calculation		
Duration	Flicker	Interval	Pst
0.1%	7.75		
0.7%	3.47		
1.0%	2.31		
1.5%	1.13		
2.2%	0.44		
3%	0.13		
4%	0.03		
6%	0.00		
8%	0.00		
10%	0.00		
13%	0.00		
17%	0.00		
30%	0.00		
50%	0.00		
80%	0.00		

7. ELECTROSTATIC DISCHARGE IMMUNITY TEST

7.1. Test Equipment

The following test equipments are used during the Electrostatic Discharge measurement:

Item	Equipment	Manufacturer	Model No.	Serial No.	Last Cal.	Cal. Interval
1.	ESD Simulators	KIKUSUI	KES4021	LJ003477	Jun. 17, 2016	1 Year

7.2. Block Diagram of Test Setup

7.2.1. Test Setup Diagram

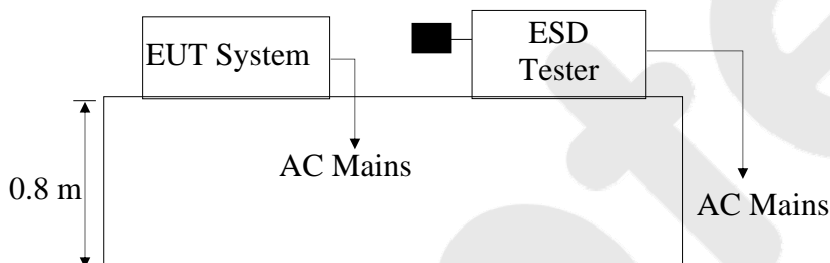

7.3. Measuring Standard

EN 61547 (IEC 61000-4-2)

Severity Level: 3 / Air Discharge: $\pm 8\text{kV}$, Level: 2 / Contact Discharge: $\pm 4\text{kV}$

7.4. Severity Levels and Performance Criterion

7.4.1. Severity level

Level	Test Voltage Contact Discharge (kV)	Test Voltage Air Discharge (kV)
1.	± 2	± 2
2.	± 4	± 4
3.	± 6	± 8
4.	± 8	± 15
X	Special	Special

7.4.2. Performance criterion: B

7.5. EUT Configuration

The following equipments are installed on Electrostatic Discharge immunity Measurement to meet EN 61547 requirements and operating in a manner which tends to maximize its emission characteristics in a normal application.

7.6. Operating Condition of EUT

- 7.6.1. Setup the EUT as shown on Section 7.2.
- 7.6.2. Turn on the power of all equipments.
- 7.6.3. After that, let the EUT work in test mode measure it.

7.7. Test Procedure

7.7.1. Air Discharge:

This test is done on a non-conductive surface. The round discharge tip of the discharge electrode shall be approached as fast as possible to touch the EUT. After each discharge, the discharge electrode shall be removed from the EUT. The generator is then re-triggered for a new single discharge and repeated 10 times for each pre-selected test point. This procedure shall be repeated until all the air discharge completed

7.7.2. Contact Discharge:

All the procedure shall be same as Section 7.7.1. except that the tip of the discharge electrode shall touch the EUT before the discharge switch is operated.

7.7.3. Indirect discharge for horizontal coupling plane

At least 20 single discharges shall be applied to the horizontal coupling plane, at points on each side of the EUT. The discharge electrode positions vertically at a distance of 0.1m from the EUT and with the discharge electrode touching the coupling plane.

7.7.4. Indirect discharge for vertical coupling plane

At least 20 single discharge shall be applied to the center of one vertical edge of the coupling plane. The coupling plane, of dimensions 0.5m X 0.5m, is placed parallel to, and positioned at a distance of 0.1m from the EUT. Discharges shall be applied to the coupling plane, with this plane in sufficient different positions that the four faces of the EUT are completely illuminated.

7.8. Measuring Results

PASS

Please refer to the following page.

Electrostatic Discharge Test Results

Shenzhen Anbotek Compliance Laboratory Limited

Air discharge :	±8.0kV	Temperature :	24°C
Contact discharge :	±4.0kV	Humidity :	53%
Power Supply :	AC 230V, 50Hz	Criterion required :	B
Test Result :	<input checked="" type="checkbox"/> Pass <input type="checkbox"/> Fail		

For each point positive 10 times and negative 10 times discharge

Location		Kind A-Air Discharge C-Contact Discharge	Result
Slot of the EUT	12 points	A	<input checked="" type="checkbox"/> A <input type="checkbox"/> B <input type="checkbox"/> C <input type="checkbox"/> D
Others	12 points	A	<input checked="" type="checkbox"/> A <input type="checkbox"/> B <input type="checkbox"/> C <input type="checkbox"/> D
Metal surface of EUT	8 points	C	<input checked="" type="checkbox"/> A <input type="checkbox"/> B <input type="checkbox"/> C <input type="checkbox"/> D
Screws	4 points	C	<input checked="" type="checkbox"/> A <input type="checkbox"/> B <input type="checkbox"/> C <input type="checkbox"/> D
HCP	4 points	C	<input checked="" type="checkbox"/> A <input type="checkbox"/> B <input type="checkbox"/> C <input type="checkbox"/> D
VCP of the front	4 points	C	<input checked="" type="checkbox"/> A <input type="checkbox"/> B <input type="checkbox"/> C <input type="checkbox"/> D
VCP of the rear	4 points	C	<input checked="" type="checkbox"/> A <input type="checkbox"/> B <input type="checkbox"/> C <input type="checkbox"/> D
VCP of the left	4 points	C	<input checked="" type="checkbox"/> A <input type="checkbox"/> B <input type="checkbox"/> C <input type="checkbox"/> D
VCP of the right	4 points	C	<input checked="" type="checkbox"/> A <input type="checkbox"/> B <input type="checkbox"/> C <input type="checkbox"/> D

Note: Discharge should be considered on Contact and Air and Horizontal Coupling Plane (HCP) and Vertical Coupling Plane (VCP).

8. RF FIELD STRENGTH SUSCEPTIBILITY TEST

8.1. Test Equipment

The following test equipments are used during the R/S (Shenzhen EMTEK) measurement:

Item	Equipment	Manufacturer	Model No.	Serial No.	Last Cal.	Cal. Interval
1.	RF Power Meter. Dual Channel	BOONTON	4232A	10539	May 29, 2016	1 year
2.	50ohm Diode Power Sensor	BOONTON	51011EMC	34236/34238	May 29, 2016	1 year
3.	Broad-Band Horn Antenna	SCHWARZBECK	BBHA9120 L3F	332	May 29, 2016	1 year
4.	Power Amplifier	PRANA	AP32MT215	N/A	May 29, 2016	1 year
5.	Power Amplifier	MILMEGA	AS0102-55	N/A	May 29, 2016	1 year
6.	Signal Generator	AEROFLEX	2023B	N/A	May 29, 2016	1 year
7.	Field Strength Meter	HOLADAY	HI-6005	N/A	May 29, 2016	1 year
8.	RS232 Fiber Optic Modem	HOLADAY	HI-4413P	N/A	May 29, 2016	1 year
9.	Log.-Per. Antenna	SCHWARZBECK	VULP 9118E	N/A	May 29, 2016	1 year

8.2. Block Diagram of Test Setup

8.2.1. R/S Test Setup

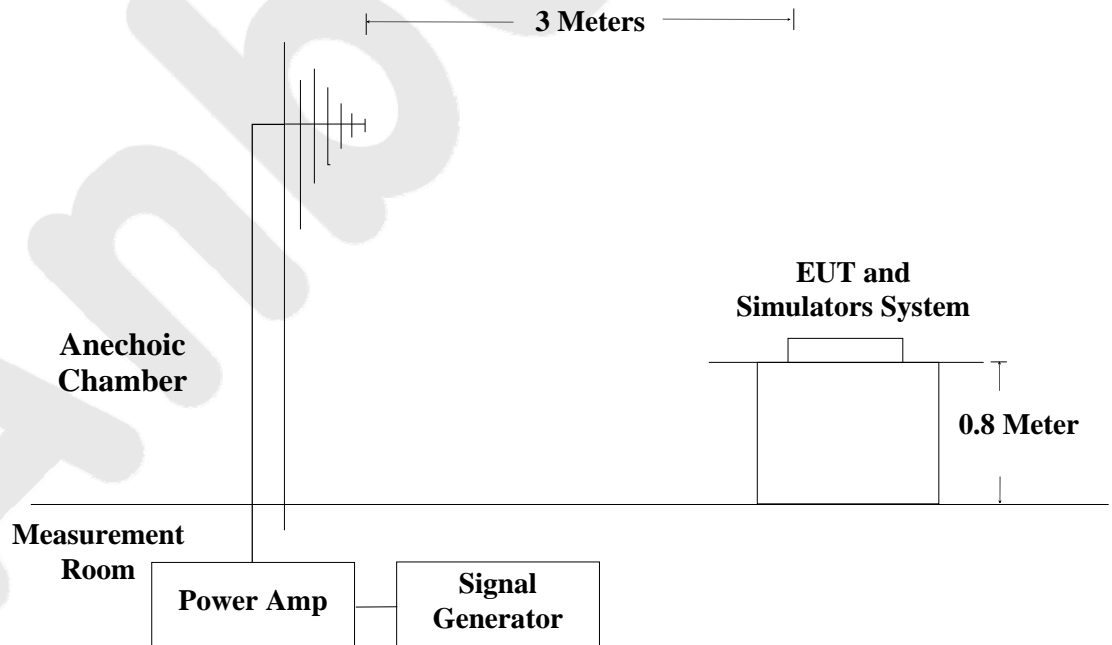

8.3. Measuring Standard

EN 61547 ((IEC 61000-4-3)
Severity Level 2: 3V/m

8.4. Severity Levels and Performance Criterion

8.4.1. Severity level

Level	Field Strength V/m
1.	1
2.	3
3.	10
X	Special

8.4.2. Performance criterion: A

8.5. EUT Configuration

The following equipments are installed on RF Field Strength susceptibility Measurement to meet EN 61547 requirements and operating in a manner which tends to maximize its emission characteristics in a normal application.

8.6. Operating Condition of EUT

8.6.1. Setup the EUT as shown on Section 8.2.

8.6.2. Turn on the power of all equipments.

8.6.3. After that, let the EUT work in test mode measure it.

8.7. Test Procedure

The EUT and its simulators are placed on a turn table which is 0.8 meter above ground. EUT is set 3 meter away from the transmitting antenna which is mounted on an antenna tower. Both horizontal and vertical polarization of the antenna are set on test. Each of the four sides of EUT must be faced this transmitting antenna and measured individually.

In order to judge the EUT performance, a CCD camera is used to monitor EUT screen. All the scanning conditions are as follow:

Condition of Test	Remarks
1. Fielded Strength	3 V/m (Severity Level 2)
2. Radiated Signal	Unmodulated
3. Scanning Frequency	80 - 1000 MHz
4. Dwell time of radiated	0.0015 decade/s
5. Waiting Time	1 Sec.

8.8. Measuring Results

PASS

Please refer to the following page.

RF Field Strength Susceptibility Test Results

Shenzhen Anbotek Compliance Laboratory Limited

Field Strength :	3V/m	Temperature :	25°C
Criterion required :	A	Humidity :	55%
Power Supply :	AC 230V, 50Hz	Test Result :	<input checked="" type="checkbox"/> Pass <input type="checkbox"/> Fail
Modulation :	<input checked="" type="checkbox"/> AM 1 KHz 80% <input type="checkbox"/> Pulse <input type="checkbox"/> none		
Steps 1 %	Frequency Rang: 80-1000MHz		Result
	Horizontal	Vertical	
Front	3V/m	3V/m	<input checked="" type="checkbox"/> A <input type="checkbox"/> B <input type="checkbox"/> C <input type="checkbox"/> D
Right	3V/m	3V/m	<input checked="" type="checkbox"/> A <input type="checkbox"/> B <input type="checkbox"/> C <input type="checkbox"/> D
Rear	3V/m	3V/m	<input checked="" type="checkbox"/> A <input type="checkbox"/> B <input type="checkbox"/> C <input type="checkbox"/> D
Left	3V/m	3V/m	<input checked="" type="checkbox"/> A <input type="checkbox"/> B <input type="checkbox"/> C <input type="checkbox"/> D
Note: The Project was tested in Shenzhen EMTEK Co., Ltd.			

9. ELECTRICAL FAST TRANSIENT/BURST IMMUNITY TEST

9.1. Test Equipment

The following test equipments are used during the Electrical Fast Transient /Burst Immunity measurement:

Item	Equipment	Manufacturer	Model No.	Serial No.	Last Cal.	Cal. Interval
1.	EFT Burst Simulator	PRIMA	EFT61004B	PR10114282	Jul. 12, 2016	1 Year
2.	EFT-Clamp	PRIMA	EFT-Clamp	/	Jul. 12, 2016	1 Year

9.2. Block Diagram of Test Setup

9.2.1. Block Diagram of the AC Mains

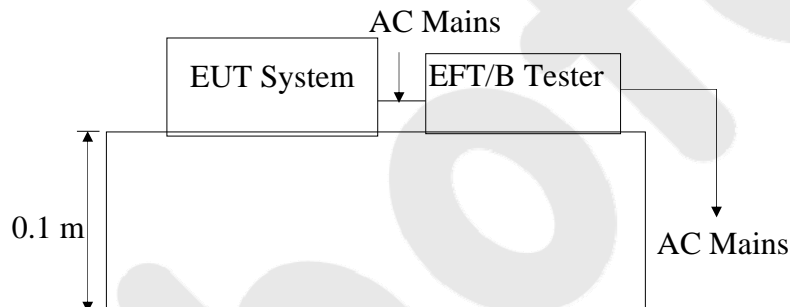

9.3. Measuring Standard

EN 61547 (IEC 61000-4-4)
Severity Level 2: 1.00kV

9.4. Severity Levels and Performance Criterion

9.4.1. Severity level

Open Circuit Output Test Voltage $\pm 10\%$		
Level	On Power Supply Lines	On I/O (Input/Output) Signal data and control lines
1.	0.50 kV	0.25 kV
2.	1.00 kV	0.50 kV
3.	2.00 kV	1.00 kV
4.	4.00 kV	2.00 kV
X	Special	Special

9.4.2. Performance criterion: B

9.5. EUT Configuration

The following equipments are installed on Electrical Fast Transient/Burst Immunity Measurement to meet EN 61547 requirements and operating in a manner which tends to maximize its emission characteristics in a normal application.

9.6. Operating Condition of EUT

- 9.6.1. Setup the EUT as shown in Section 9.2.
- 9.6.2. Turn on the power of all equipments.
- 9.6.3. Let the EUT work in test mode and measure it.

9.7. Test Procedure

The EUT is put on the table which is 0.1 meter high above the ground. This reference ground plane shall project beyond the EUT by at least 0.1m on all sides and the minimum distance between EUT and all other conductive structure, except the ground plane beneath the EUT, shall be more than 0.5m.

9.7.1. For input and output AC power ports:

The EUT is connected to the power mains by using a coupling device which couples the EFT interference signal to AC power lines. Both polarities of the test voltage should be applied during compliance test and the duration of the test is 2 mins.

9.7.2. For signal lines and control lines ports:

It's unnecessary to test.

9.7.3. For DC output line ports:

It's unnecessary to test.

9.8. Measuring Results

PASS

Please refer to the following page.

Electrical Fast Transient/Burst Test Results

Shenzhen Anbotek Compliance Laboratory Limited

Ambient Condition : 25°C / 56% RH		Criterion required : B	
Power Supply .: AC 230V, 50Hz		Test Result : <input checked="" type="checkbox"/> Pass <input type="checkbox"/> Fail	
Inject Line : AC Mains		Inject Method: Direct	Inject Time(s): 120
Line	Polarity	Test Voltage	Result
L	±	1.00kV	<input checked="" type="checkbox"/> A <input type="checkbox"/> B <input type="checkbox"/> C <input type="checkbox"/> D
N	±	1.00kV	<input checked="" type="checkbox"/> A <input type="checkbox"/> B <input type="checkbox"/> C <input type="checkbox"/> D
PE	±	1.00kV	<input checked="" type="checkbox"/> A <input type="checkbox"/> B <input type="checkbox"/> C <input type="checkbox"/> D
L、N	±	1.00kV	<input checked="" type="checkbox"/> A <input type="checkbox"/> B <input type="checkbox"/> C <input type="checkbox"/> D
L、PE	±	1.00kV	<input checked="" type="checkbox"/> A <input type="checkbox"/> B <input type="checkbox"/> C <input type="checkbox"/> D
N、PE	±	1.00kV	<input checked="" type="checkbox"/> A <input type="checkbox"/> B <input type="checkbox"/> C <input type="checkbox"/> D
L、N、PE	±	1.00kV	<input checked="" type="checkbox"/> A <input type="checkbox"/> B <input type="checkbox"/> C <input type="checkbox"/> D
Signal Line			
DC output Line			
Note :			
Remark:			

10. SURGE IMMUNITY TEST

10.1. Test Equipment

The following test equipments are used during the Surge Immunity measurement:

Item	Equipment	Manufacturer	Model No.	Serial No.	Last Cal.	Cal. Interval
1.	6kV Surge Generator	EMPEK	LSG-5060G	06010017N	Jul. 12, 2016	1 Year
2.	CDN	EMPEK	CDN-5110G	061100005N	Jul. 12, 2016	1 Year

10.2. Block Diagram of Test Setup

10.2.1. Surge Test Setup

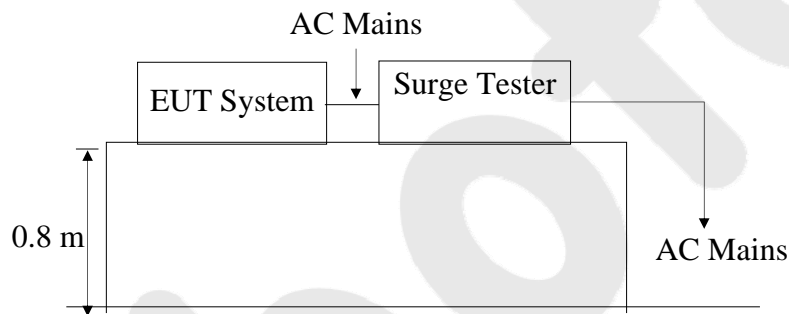

10.3. Measuring Standard

EN61547 (IEC61000-4-5)

(Severity Level: Level 2, Line to Line: 1.0kV; Level 3, Line to Earth: 2.0kV)

10.4. Severity Levels and Performance Criterion

10.4.1. Severity level

Severity Level	Open-Circuit Test Voltage kV
1	0.5
2	1.0
3	2.0
4	4.0
X	Special

10.4.2. Performance criterion: **B**

10.5. EUT Configuration

The following equipments are installed on Surge immunity Measurement to meet EN 61547 requirements and operating in a manner which tends to maximize its emission characteristics in a normal application.

10.6. Operating Condition of EUT

10.6.1. Setup the EUT as shown in Section 10.2.

10.6.2. Turn on the power of all equipments.

10.6.3. Let the EUT work in test mode and measure it.

10.7. Test Procedure

- 1) Set up the EUT and test generator as shown on Section 10.2.1.
- 2) For line to line coupling mode, provide a 1.0 kV 1.2/50us voltage surge (at open-circuit condition) and 8/20us current surge to EUT selected points.
- 3) For line to Earth coupling mode, provide a 2.0 kV 1.2/50us voltage surge (at open-circuit condition) and 8/20us current surge to EUT selected points.
- 4) At least 5 positive and 5 negative (polarity) tests with a maximum 1/min repetition rate are conducted during test.
- 5) Different phase angles are done individually.
- 6) Record the EUT operating situation during compliance test and decide the EUT immunity criterion for above each test.

10.8. Measuring Results

PASS

Please refer to the following page

Surge Immunity Test Results

Shenzhen Anbotek Compliance Laboratory Limited

Humidity :	56%	Temperature :	25°C
Power Supply :	AC 230V, 50Hz	Criterion required:	B
Test Result :	<input checked="" type="checkbox"/> Pass <input type="checkbox"/> Fail		

Location	Polarity	Phase Angle	Number of Pulse	Pulse Voltage (kV)	Result
L-N	±	<input type="checkbox"/> 0° <input checked="" type="checkbox"/> 90° <input type="checkbox"/> 180° <input checked="" type="checkbox"/> 270°	5	1.0	<input checked="" type="checkbox"/> A <input type="checkbox"/> B <input type="checkbox"/> C <input type="checkbox"/> D
L-PE	±	<input type="checkbox"/> 0° <input checked="" type="checkbox"/> 90° <input type="checkbox"/> 180° <input checked="" type="checkbox"/> 270°	5	2.0	<input checked="" type="checkbox"/> A <input type="checkbox"/> B <input type="checkbox"/> C <input type="checkbox"/> D
N-PE	±	<input type="checkbox"/> 0° <input checked="" type="checkbox"/> 90° <input type="checkbox"/> 180° <input checked="" type="checkbox"/> 270°	5	2.0	<input checked="" type="checkbox"/> A <input type="checkbox"/> B <input type="checkbox"/> C <input type="checkbox"/> D

Remark:

11. INJECTED CURRENTS SUSCEPTIBILITY TEST

11.1. Test Equipment

The following test equipments are used during the Injected Current Susceptibility measurement:

Item	Equipment	Manufacturer	Model No.	Serial No.	Last Cal.	Cal. Interval
1.	C/S Conducted Immunity Test System	FRANKONIA	CIT-10	126A1196/2012	Apr. 16, 2016	1 Year
2.	CDN	FRANKONIA	CDN - M2+ M3	A2210178/2012	Jun. 18, 2016	1 Year
3.	6dB attenuator	FRANKONIA	DAM 26W	1172202	Jun. 17, 2016	1 Year

11.2. Block Diagram of Test Setup

11.2.1. Block Diagram of AC Mains

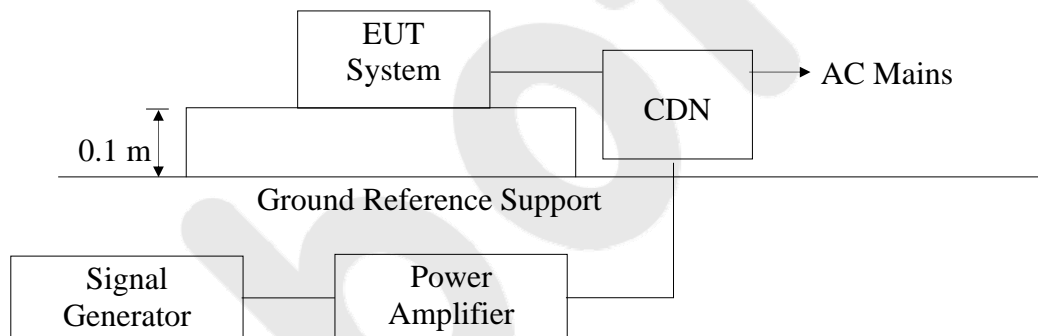

11.3. Measuring Standard

EN 61547 (IEC 61000-4-6)
Severity Level 2: 3V (rms), (0.15MHz ~80MHz)

11.4. Severity Levels and Performance Criterion

11.4.1. Severity level

Level	Field Strength V
1.	1
2.	3
3.	10
X	Special

11.4.2. Performance criterion: A

11.5. EUT Configuration

The following equipments are installed on currents susceptibility Measurement to meet EN 61547 requirements and operating in a manner which tends to maximize its emission characteristics in a normal application.

11.6. Operating Condition of EUT

11.6.1. Setup the EUT as shown in Section 11.2.

11.6.2. Turn on the power of all equipments.

11.6.3. Let the EUT work in test mode and measure it.

11.7. Test Procedure

- 1) Set up the EUT, CDN and test generators as shown on Section 11.2.1.
- 2) Let the EUT work in test mode and measure it.
- 3) The EUT are placed on an insulating support 0.1m high above a ground reference plane. CDN (coupling and decoupling device) is placed on the ground plane about 0.3m from EUT. Cables between CDN and EUT are as short as possible, and their height above the ground reference plane shall be between 30 and 50 mm (where possible).
- 4) The disturbance signal described below is injected to EUT through CDN.
- 5) The EUT operates within its operational mode(s) under intended climatic conditions after power on.
- 6) The frequency range is swept from 150KHz to 80MHz using 3V signal level, and with the disturbance signal 80% amplitude modulated with a 1KHz sine wave.
- 7) The rate of sweep shall not exceed 1.5×10^{-3} decades/s. Where the frequency is swept incrementally, the step size shall not exceed 1% of the start and thereafter 1% of the preceding frequency value.
- 8) Recording the EUT operating situation during compliance testing and decide the EUT immunity criterion.

11.8. Measuring Results

PASS

Please refer to the following page.

Injected Currents Susceptibility Test Results

Shenzhen Anbotek Compliance Laboratory Limited

Humidity : 56%		Temperature : 24°C	
Power Supply : AC 230V, 50Hz		Criterion required: A	
Test Result : <input checked="" type="checkbox"/> Pass <input type="checkbox"/> Fail			
Frequency Range (MHz)	Injected Position	Strength (Unmodulated)	Result
0.15 ~ 80	AC Mains	3V	<input checked="" type="checkbox"/> A <input type="checkbox"/> B <input type="checkbox"/> C <input type="checkbox"/> D
Frequency Range (MHz)	Injected Position	Strength (Unmodulated)	Result
Remark : 1. Modulation Signal:1KHz 80% AM			

12. VOLTAGE DIPS AND INTERRUPTIONS TEST

12.1. Test Equipment

The following test equipments are used during the Dips Immunity measurement:

Item	Equipment	Manufacturer	Model No.	Serial No.	Last Cal.	Cal. Interval
1.	CYCLE SAG Simulator	PRIMA	DRP61011AG	PR12046234	Jun. 17, 2016	1 Year

12.2. Block Diagram of Test Setup

12.2.1. Dips Test Setup

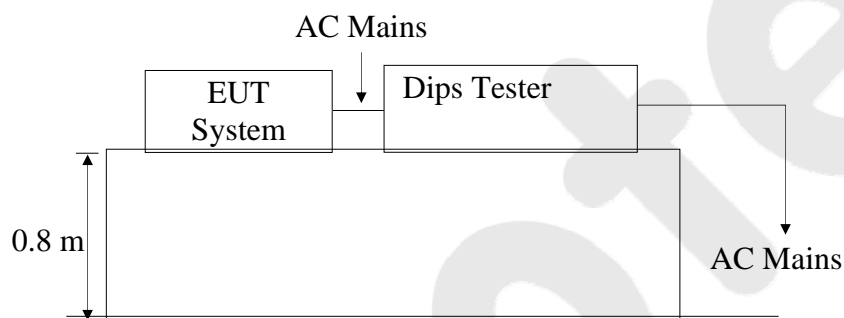

12.3. Measuring Standard

EN 61547 (IEC 61000-4-11)

12.4. Severity Levels and Performance Criterion

12.4.1. Severity level

Test Level %U _T	Voltage dip and short interruptions %U _T	Duration (in period)
0	100	0.5
70	30	10
		*

12.4.2. Performance criterion: B&C

12.5. EUT Configuration

The following equipments are installed on Voltage dips and interruptions Measurement to meet EN 61547 requirements and operating in a manner which tends to maximize its emission characteristics in a normal application.

12.6. Operating Condition of EUT

12.6.1. Setup the EUT as shown in Section 12.2.

12.6.2. Turn on the power of all equipments.

12.6.3. Let the EUT work in test mode and measure it.

12.7. Test Procedure

- 1) Set up the EUT and test generator as shown on Section 12.2.1.
- 2) The interruptions is introduced at selected phase angles with specified duration.
- 3) Record any degradation of performance.

12.8. Measuring Results

PASS

Please refer to the following page.

Voltage Dips and Interruptions Test Results

Shenzhen Anbotek Compliance Laboratory Limited

Temperature : 25°C

Humidity : 56%

Power Supply : AC 230V, 50Hz

Criterion required : B&C

Test Result : Pass Fail

Test Level % U _T	Voltage Dips & Short Interruptions % U _T	Duration (in periods)	Result
70	30	10P	<input type="checkbox"/> A <input checked="" type="checkbox"/> B <input type="checkbox"/> C <input type="checkbox"/> D
0	100	0.5P	<input type="checkbox"/> A <input type="checkbox"/> B <input checked="" type="checkbox"/> C <input type="checkbox"/> D

Test Level % U _T	Voltage Dips & Short Interruptions % U _T	Duration (in periods)	Result

Remark:

13. PHOTOGRAPHS

13.1. Photo of Power Line Conducted Emission Test



13.2. Photo of Radiated Emission Test

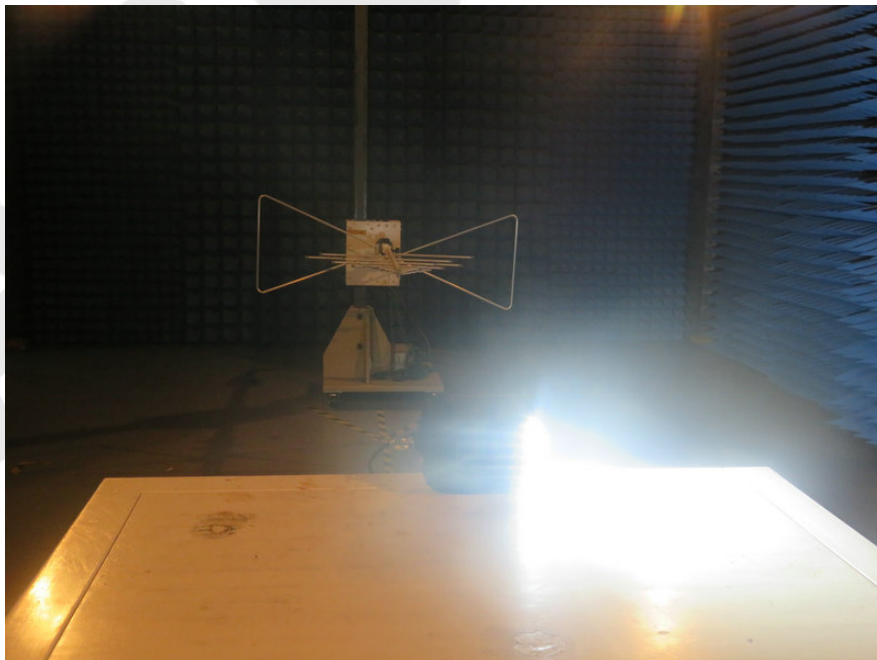

13.3. Photo of Magnetic Radiated Emission Test



13.4. Photo of Flicker/ Harmonic Test

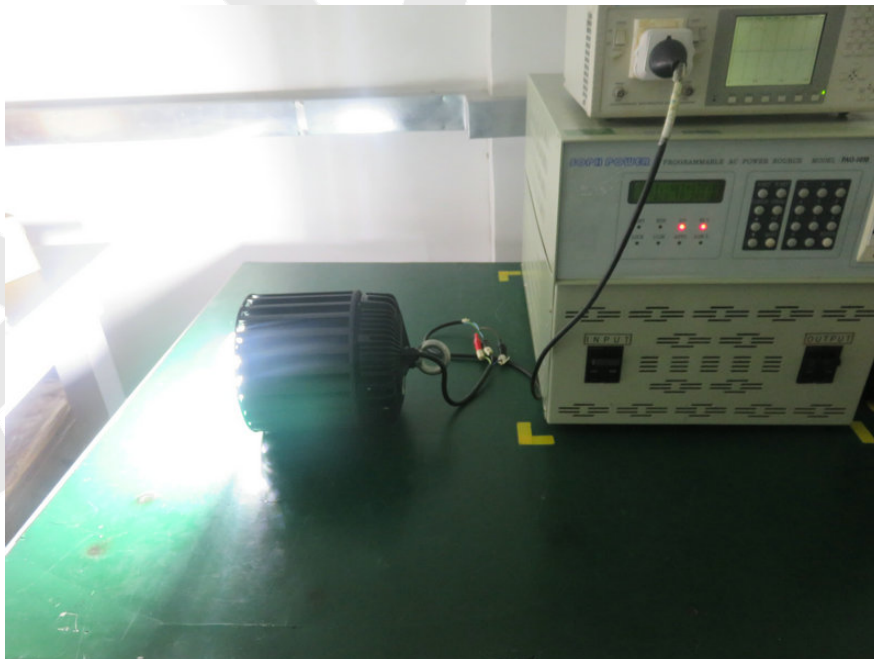

13.5. Photo of Electrostatic Discharge Immunity Test



13.6. Photo of RF Field Strength susceptibility Test

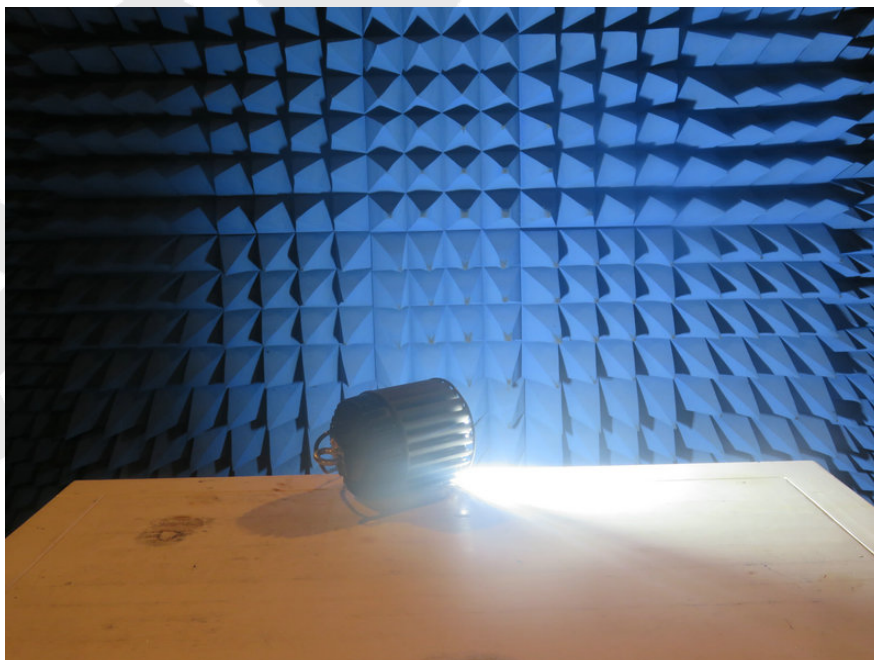

13.7. Photo of Electrical Fast Transient/Burst Immunity Test

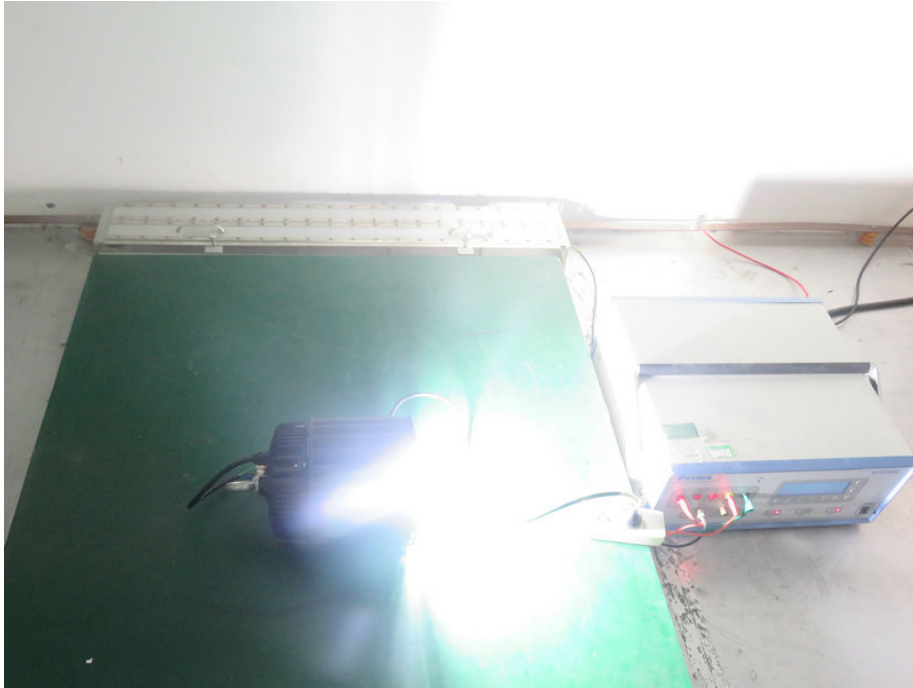

13.8. Photo of Surge Immunity Test



13.9. Photo of Injected currents susceptibility Test



13.10. Photo of Voltage Dips and Interruptions Test

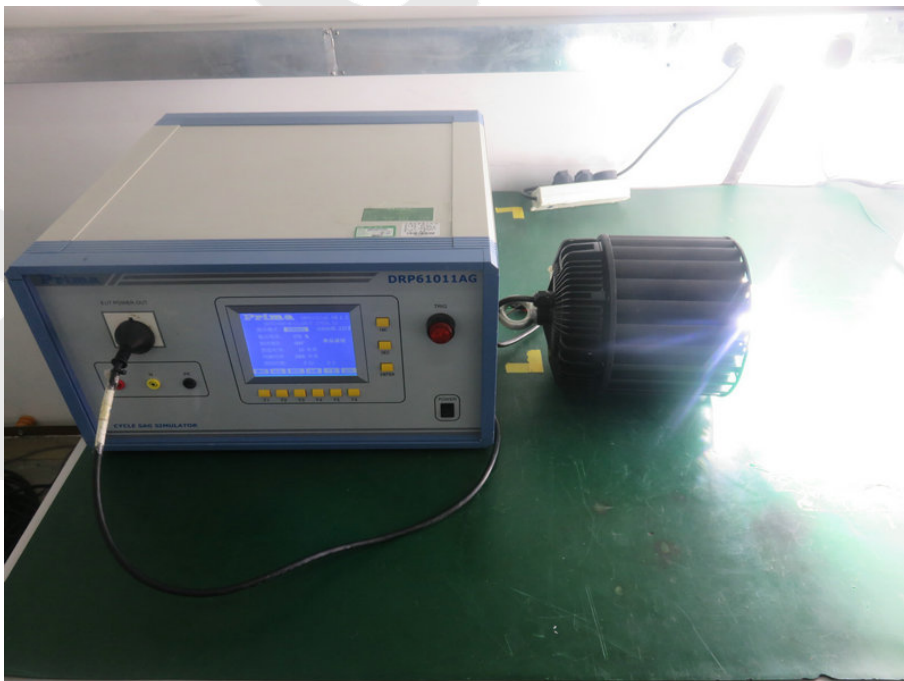

APPENDIX I
(Photos of EUT)

Figure 1
The EUT- Front View

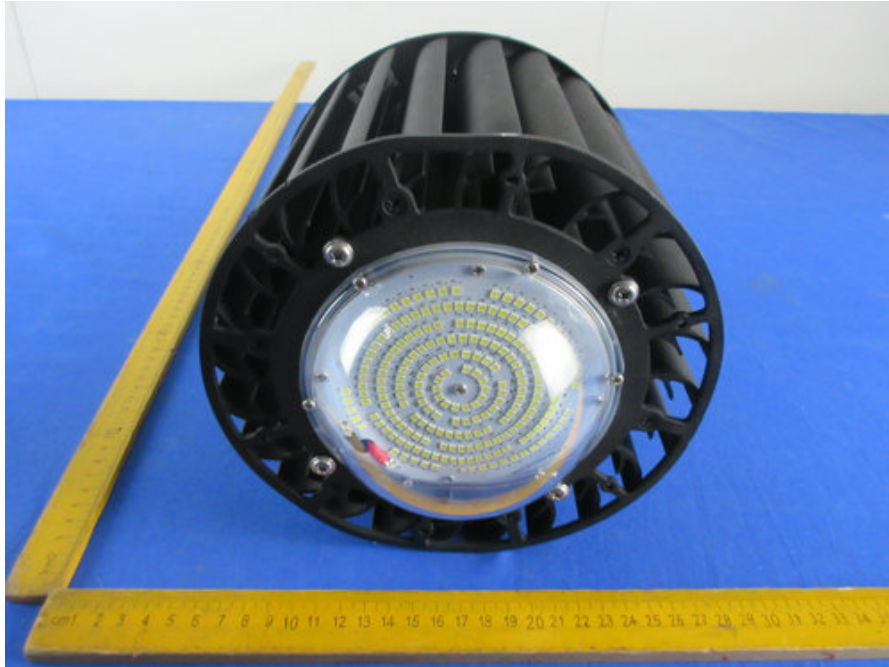

Figure 2
The EUT- Side View



Figure 3
The EUT- Back View



Figure 4
The EUT- Inside View



Figure 5
The EUT- Driver View



Figure 6
The EUT- Inside View

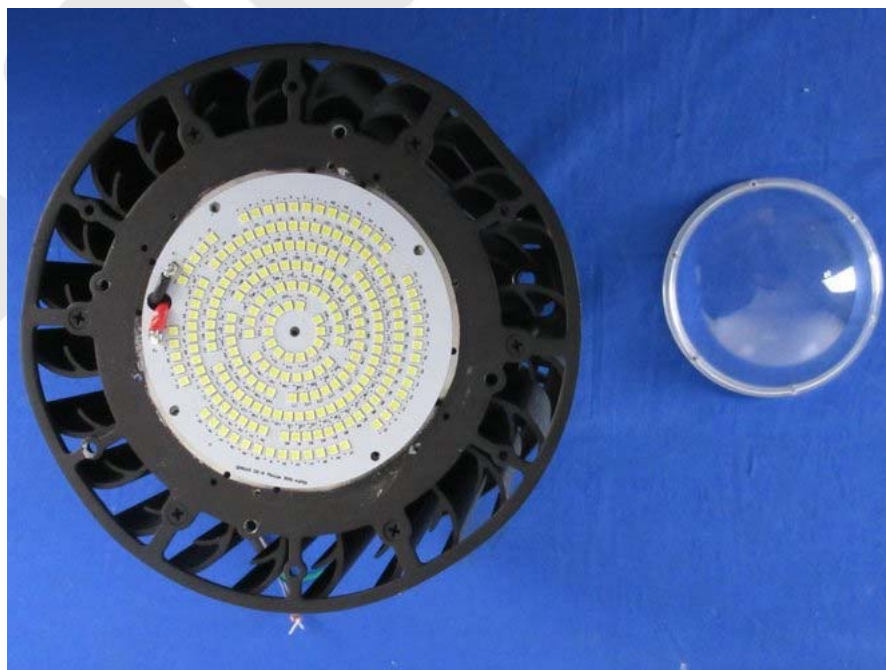
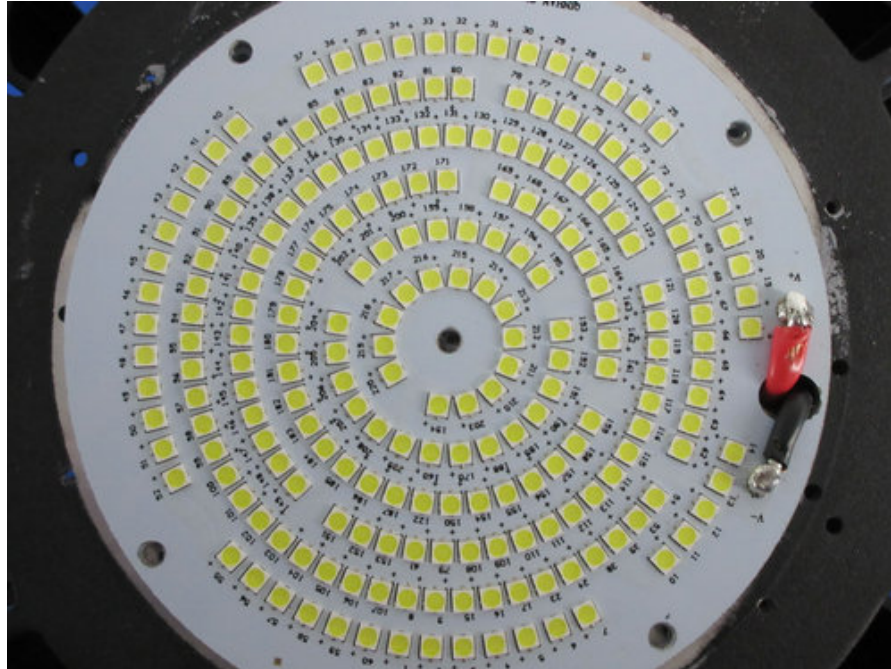

Figure 7
The EUT- Inside View



CE Label

1. The CE conformity marking must consist of the initials 'CE' taking the following form:
If the CE marking is reduced or enlarged, the proportions given in the above graduated drawing must be respected.
2. The CE marking must have a height of at least 5 mm except where this is not possible on account of the nature of the apparatus.
3. The CE marking must be affixed to the product or to its data plate. Additionally it must be affixed to the packaging, if any, and to the accompanying documents.
4. The CE marking must be affixed visibly, legibly and indelibly.
It must have the same height as the initials 'CE'.

Anbotek