

GENERAL FEATURES

- True Deep cycle construction
- Thick plate with high Tin low Calcium alloy
- High Reliability and Good Quality
- Deep Discharge Recovery
- High Power Density
- Long float and cyclic service life

APPLICATIONS

- Golf/Utility Vehicles
- Floor Machines
- Aerial Work Platform
- Recreational Vehicles(RV)
- Medical Mobility/Marine Vessels
- Neighborhood Electric Vehicles(NEV)
- Renewable Energy Systems



Length(mm)	484±1
Width(mm)	171±1
Height(mm)	241±1
Total Height(mm)	241±1
Weight(kg)	45.5±3%

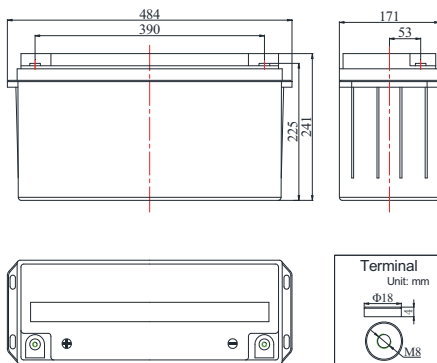

COMPLIED STANDARDS

IEC 60896-21/22	JIS C8704
YD/T799	BS6290 part4
GB/T 19638	UL 1989

TECHNICAL SPECIFICATIONS

Nominal Voltage		12V(6 cells per unit)
Design Floating Life @25°C		12 Years
Nominal Capacity @25°C(20 hour rate@7.50A,10.50V)		150Ah
Capacity @25°C	10 hour rate (13.65A,10.8V)	136.5Ah
	5 hour rate (23.9A,10.5V)	119.5Ah
	1 hour rate (83.4A,9.6V)	83.4Ah
Internal Resistance	Full Charged Battery@25°C	≤4.0mΩ
Ambient Temperature	Discharge	-20°C~50°C
	Charge	-20°C~50°C
	Storage	-20°C~50°C
Max.Discharge Current@25°C		1500A(5s)
Capacity affected by Temperature (10 hr Capacity)	40°C	102%
	25°C	100%
	0°C	85%
	-15°C	65%
Self-Discharge@25°C per Month		3%
Charge (Constant Voltage) @25°C	Standby Use	Initial Charging Current Less than 27A Voltage 13.6-13.8V
	Cycle Use	Initial Charging Current Less than 27A Voltage 14.4-14.9V

BATTERY DISCHARGE TABEL

Discharge Constant Current per Cell (Amperes at 25°C)

F.V/Time	15min	30min	45min	1h	2h	3h	5h	8h	10h	20h	100h
1.60V	193.1	123.3	90.6	83.4	53.0	37.2	25.2	16.7	14.85	7.95	1.80
1.67V	189.6	121.1	89.0	81.8	51.9	36.5	24.8	16.4	14.55	7.80	1.77
1.70V	186.0	118.8	87.3	80.3	51.0	35.9	24.3	16.1	14.25	7.65	1.73
1.75V	182.6	116.6	85.7	78.8	50.0	35.1	23.9	15.8	14.10	7.50	1.70
1.80V	175.5	112.1	82.4	75.8	48.0	33.8	23.0	15.2	13.65	7.43	1.67

Discharge Constant Power per Cell (Watts at 25°C)

F.V/Time	15min	30min	45min	1h	2h	3h	5h	8h	10h	20h	100h
1.60V	371.6	237.3	174.5	160.1	101.7	71.4	48.6	32.0	28.7	15.5	3.47
1.67V	364.8	233.0	171.2	157.2	99.9	70.2	47.7	31.5	28.1	15.2	3.39
1.70V	358.1	228.6	168.0	154.2	98.1	68.9	46.8	30.9	27.6	15.1	3.33
1.75V	351.3	224.3	164.9	151.4	96.2	67.5	45.9	30.3	27.0	14.9	3.27
1.80V	337.8	215.7	158.6	145.5	92.6	65.0	44.3	29.1	26.0	14.4	3.21

Note The above data are average values, and can be obtained within 3 charge/discharge cycles. These are not minimum values. Cell and battery designs/specifications are subject to modification without notice. Contact **CBB** for the latest information.

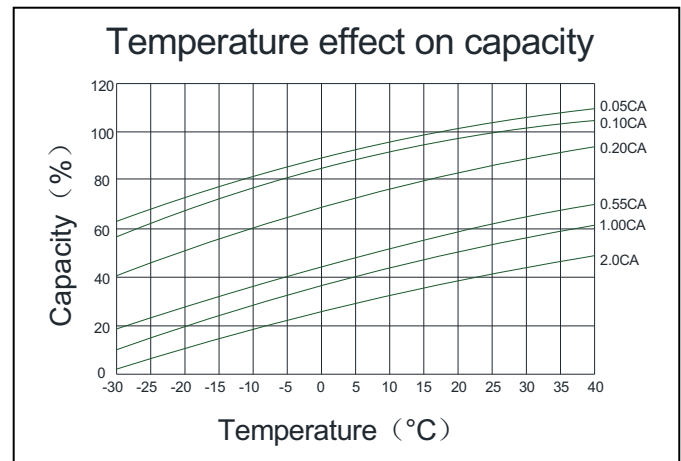
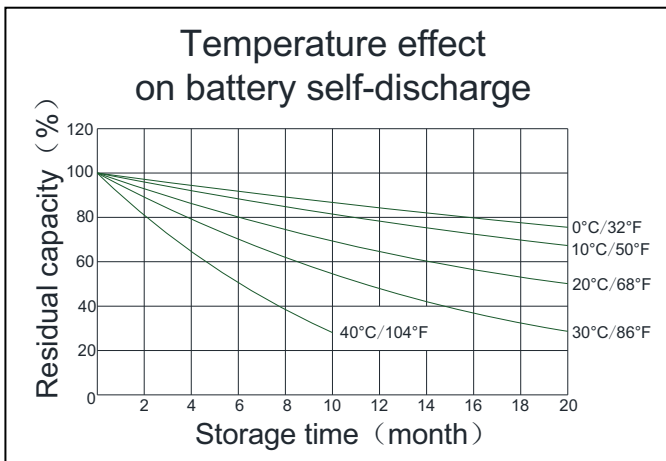
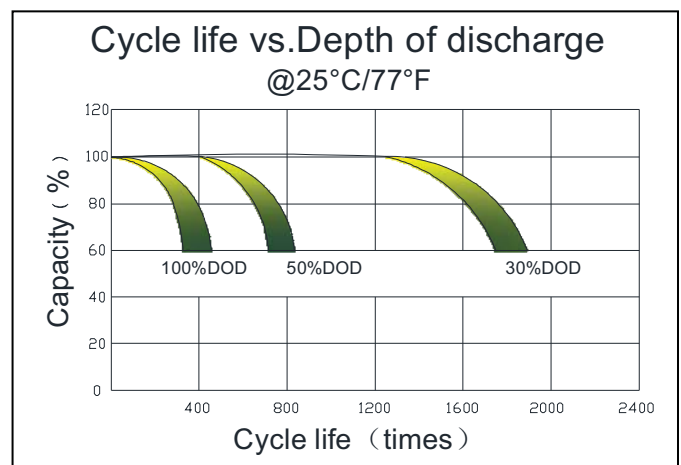
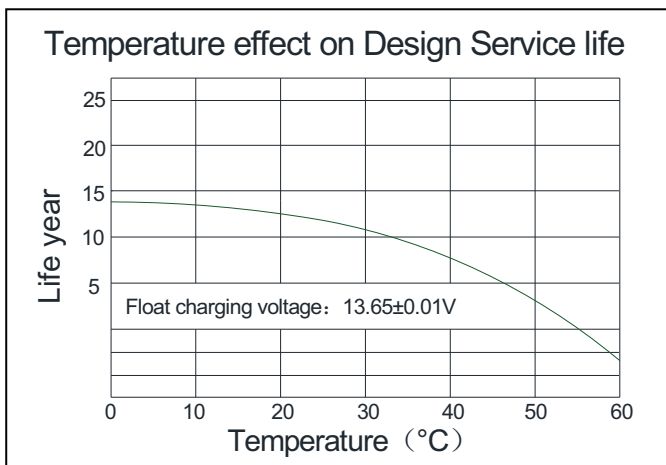
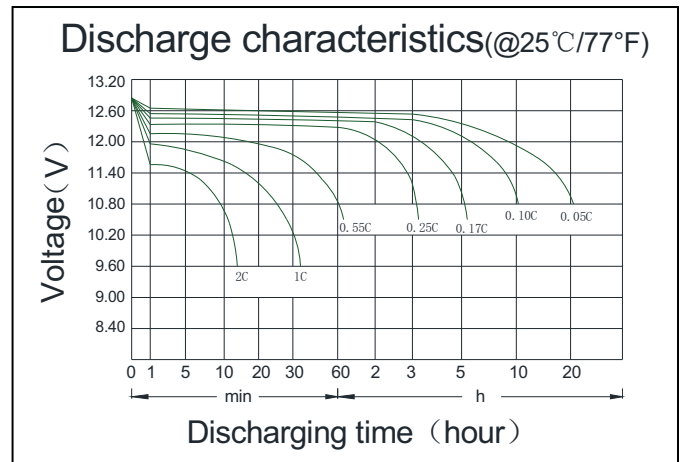
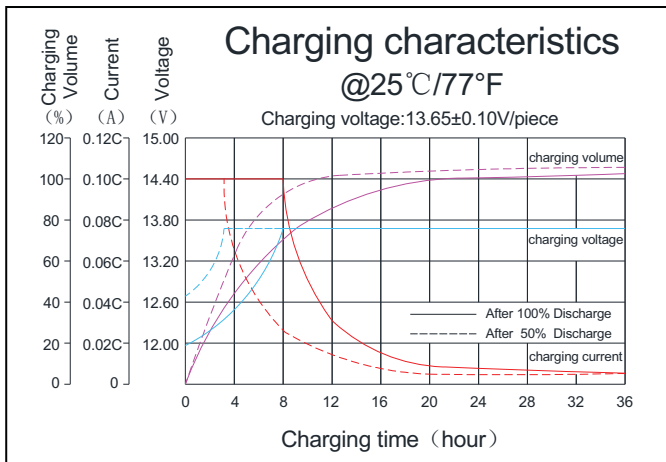

BATTERY CONSTRUCTION

Component	Positive plate	Negative plate	Container & Cover	Safety valve	Terminal	Separator	Electrolyte	Pillar seal
Features	Thick high Sn low Ca grid with special paste	Balanced Pb-Ca grid for improved recombination efficiency	ABS (UL94-V0 optional)	Flame Si-Rubber aging resistancer	Female Copper Insert M8(torque:7~9N.m)	Advanced AGM separator for high pressure cell design	Dilute high purity sulphuric acid	Two layers epoxy resin seal