

GENERAL FEATURES

- Environmentally friendly
- Can be used at vertical or horizontal orientation
- High Reliability and Good Quality
- High gas recombination efficiency
- High Power Density
- Maintenance-Free Operation

APPLICATIONS

- UPS & EPS
- Emergency lighting Systems
- Medical Equipment
- Cable TV Systems
- Alarm Systems
- Electric Test Equipment
- Security Systems



DIMENSIONS & WEIGHT

Length(mm)	151±1
Width(mm)	65±1
Height(mm)	94±1
Total Height(mm)	100±1
Weight(kg)	2.20±3%

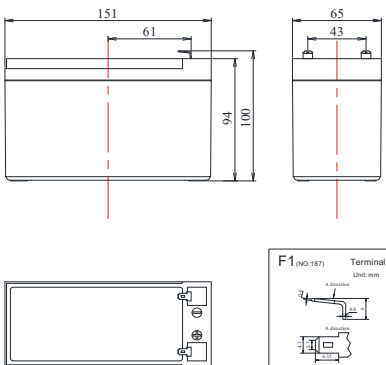

COMPLIED STANDARDS

IEC 60896-21/22	JIS C8704
YD/T799	BS6290 part4
GB/T 19639	UL 1989

TECHNICAL SPECIFICATIONS



Nominal Voltage		12V(6 cells per unit)
Design Floating Life @25°C		5 Years
Nominal Capacity @25°C (20 hour rate@0.375A,10.50V)		7.50Ah
Capacity @25°C	10 hour rate (0.71A,10.8V)	7.10Ah
	5 hour rate (1.34A,10.5V)	6.70Ah
	1 hour rate (4.90A,9.6V)	4.90Ah
Internal Resistance	Full Charged Battery@25°C	≤21.0mΩ
Ambient Temperature	Discharge	-20°C~50°C
	Charge	-20°C~50°C
	Storage	-20°C~50°C
Max.Discharge Current@25°C		110A(5s)
Capacity affected by Temperature (10 hr Capacity)	40°C	102%
	25°C	100%
	0°C	85%
	-15°C	65%
Self-Discharge@25°C per Month		3%
Charge (Constant Voltage) @25°C	Floating Charge	Initial Charging Current Less than 2.25A Voltage 13.6-13.8V
	Cycle Charge	Initial Charging Current Less than 2.25A Voltage 14.4-14.9V

BATTERY DISCHARGE TABLE

Discharge Constant Current per Cell (Amperes at 25°C)

F.V/Time	5min	10min	15min	30min	45min	1h	2h	3h	5h	8h	10h	20h
1.60V	29.94	19.63	14.41	8.55	6.24	4.90	3.10	2.12	1.41	0.95	0.75	0.396
1.67V	28.52	18.81	14.10	8.41	6.14	4.74	3.04	2.08	1.39	0.93	0.74	0.389
1.70V	27.32	17.79	13.91	8.30	6.06	4.59	2.98	2.05	1.36	0.91	0.73	0.383
1.75V	26.04	16.96	13.17	8.03	5.90	4.45	2.93	2.00	1.34	0.90	0.72	0.375
1.80V	24.05	15.80	12.29	7.70	5.71	4.32	2.82	1.93	1.29	0.88	0.71	0.371

Discharge Constant Power per Cell (Watts at 25°C)

F.V/Time	5min	10min	15min	30min	45min	1h	2h	3h	5h	8h	10h	20h
1.60V	55.75	37.67	27.86	16.64	12.17	9.63	6.08	4.18	2.80	1.89	1.50	0.791
1.67V	53.42	36.15	27.32	16.40	12.01	9.30	5.97	4.11	2.75	1.87	1.49	0.779
1.70V	51.23	34.19	27.01	16.22	11.89	8.97	5.86	4.03	2.70	1.84	1.48	0.769
1.75V	49.07	32.64	25.63	15.73	11.60	8.64	5.75	3.95	2.65	1.82	1.45	0.753
1.80V	45.75	30.53	23.96	15.15	11.25	8.30	5.52	3.80	2.55	1.78	1.44	0.750

Note The above data are average values, and can be obtained within 3 charge/discharge cycles. These are not minimum values. Cell and battery designs/specifications are subject to modification without notice. Contact **CBB** for the latest information.

PERFORMANCE CHARACTERISTICS

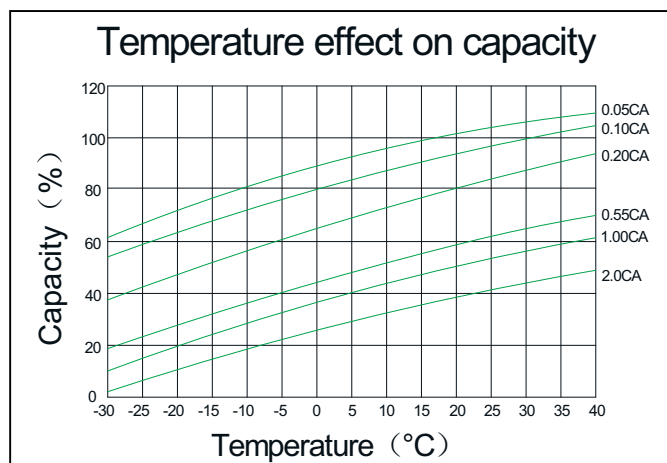
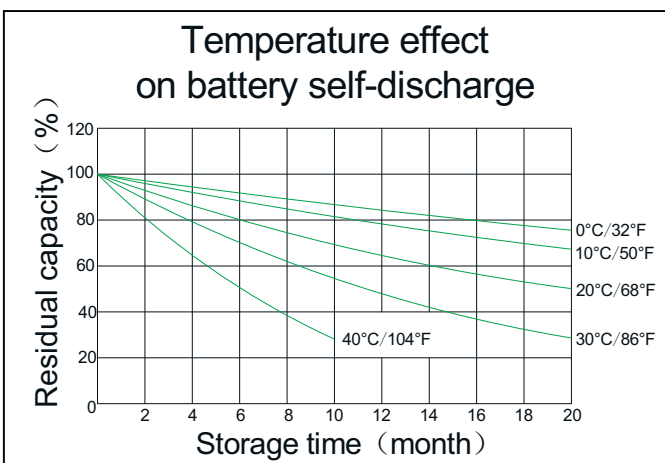
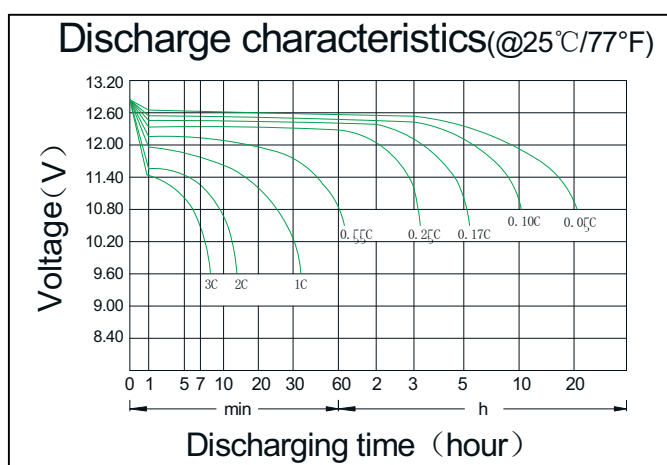
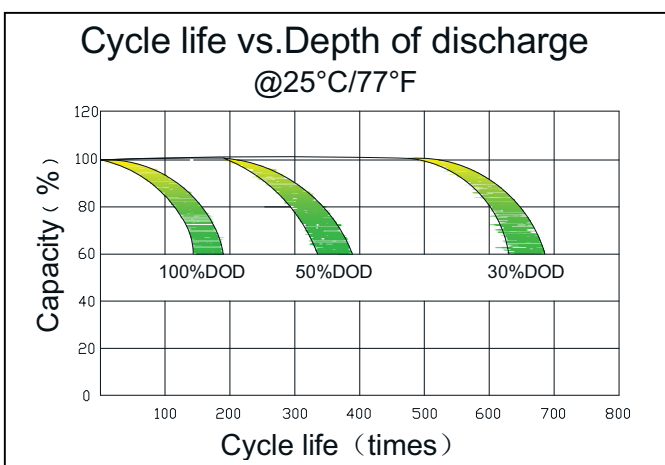
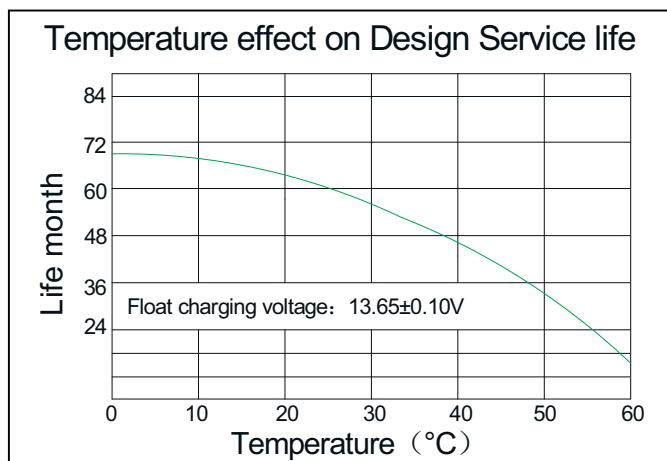
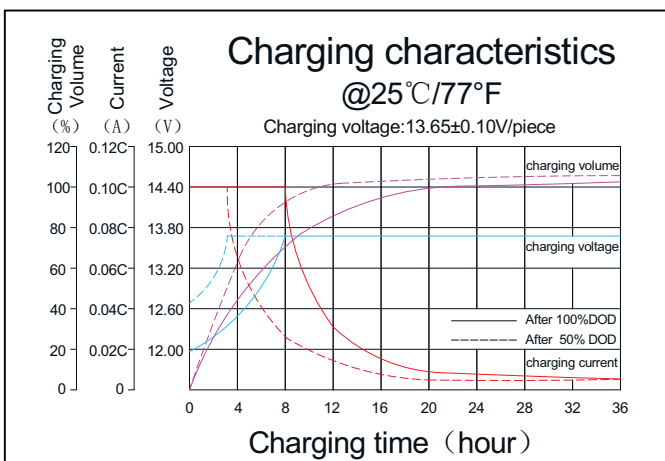

BATTERY CONSTRUCTION

Component	Positive plate	Negative plate	Container & Cover	Safety valve	Terminal	Separator	Electrolyte	Pillar seal
Features	Thick high Sn low Ca grid with special paste	Balanced Pb-Ca grid for improved recombination efficiency	ABS (UL94-V0 optional)	Flame Si-Rubbeand aging resistancer	Female Copper Insert (F1/F2)	Advanced AGM separator for high pressure cell design	Dilute high purity sulphuric acid	Two layers epoxy resin seal

CBB Battery Technology Co.,Ltd.

RM504,55 Hanxing Zhong Road,Zhongcun, Panyu,Guangzhou 511495 China

Tel: +86-020-84888946 Fax: +86-020-62824569

Copyright©2017 CBB Battery Technology Co., Ltd.

Koyama®

www.cbb-battery.com