

GENERAL FEATURES

- True Deep cycle construction
- Thick plate with high Tin low Calcium alloy
- High Reliability and Good Quality
- Deep Discharge Recovery
- High Power Density
- Long float and cyclic service life

APPLICATIONS

- Golf/Utility Vehicles
- Floor Machines
- Aerial Work Platform
- Recreational Vehicles(RV)
- Medical Mobility/Marine Vessels
- Neighborhood Electric Vehicles(NEV)
- Renewable Energy Systems



TECHNICAL SPECIFICATIONS

Length(mm)	522±1
Width(mm)	240±1
Height(mm)	219±1
Total Height(mm)	223±1
Weight(kg)	65.0±3%

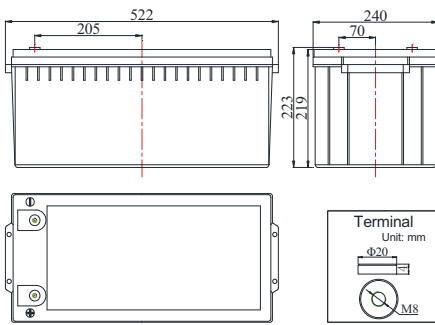

Nominal Voltage		12V(6 cells per unit)
Design Floating Life @25°C		12 Years
Nominal Capacity @25°C(20 hour rate@10.00A,10.50V)		220Ah
Capacity @25°C	10 hour rate (20.02A,10.8V)	200.2Ah
	5 hour rate (35.00A,10.5V)	175.0Ah
	1 hour rate (122.3A,9.6V)	122.3Ah
Internal Resistance	Full Charged Battery@25°C	≤3.2mΩ
Ambient Temperature	Discharge	-20°C~50°C
	Charge	-20°C~50°C
	Storage	-20°C~50°C
Max.Discharge Current@25°C		2200A(5s)
Capacity affected by Temperature (10 hr Capacity)	40°C	102%
	25°C	100%
	0°C	85%
	-15°C	65%
Self-Discharge@25°C per Month		3%
Charge (Constant Voltage) @25°C	Standby Use	Initial Charging Current Less than 39.6A Voltage 13.6-13.8V
	Cycle Use	Initial Charging Current Less than 39.6A Voltage 14.4-14.9V

COMPLIED STANDARDS

IEC 60896-21/22	JIS C8704
YD/T799	BS6290 part4
GB/T 19638	UL 1989

BATTERY DISCHARGE TABLE

Discharge Constant Current per Cell (Amperes at 25°C)

F.V/Time	15min	30min	45min	1h	2h	3h	5h	8h	10h	20h	100h
1.60V	283.1	180.8	132.9	122.3	77.7	54.6	37.0	24.4	21.78	11.66	2.64
1.67V	278.1	177.5	130.5	119.9	76.1	53.5	36.3	24.0	21.34	11.44	2.60
1.70V	272.8	174.2	128.0	117.7	74.8	52.6	35.6	23.5	20.90	11.22	2.53
1.75V	267.7	170.9	125.6	115.5	73.3	51.5	35.0	23.1	20.68	11.00	2.49
1.80V	257.4	164.3	120.8	111.1	70.4	49.5	33.7	22.2	20.02	10.89	2.44

Discharge Constant Power per Cell (Watts at 25°C)

F.V/Time	15min	30min	45min	1h	2h	3h	5h	8h	10h	20h	100h
1.60V	544.9	348.0	255.9	234.7	149.2	104.7	71.3	46.9	42.0	22.7	5.08
1.67V	535.0	341.7	251.0	230.6	146.5	103.0	70.0	46.2	41.1	22.3	4.97
1.70V	525.1	335.3	246.4	226.2	143.9	101.0	68.6	45.3	40.5	22.1	4.88
1.75V	515.2	328.9	241.8	222.0	141.0	99.0	67.3	44.4	39.6	21.8	4.80
1.80V	495.4	316.4	232.5	213.4	135.7	95.3	64.9	42.7	38.1	21.1	4.71

Note The above data are average values, and can be obtained within 3 charge/discharge cycles. These are not minimum values. Cell and battery designs/specifications are subject to modification without notice. Contact **CBB** for the latest information.

PERFORMANCE CHARACTERISTICS

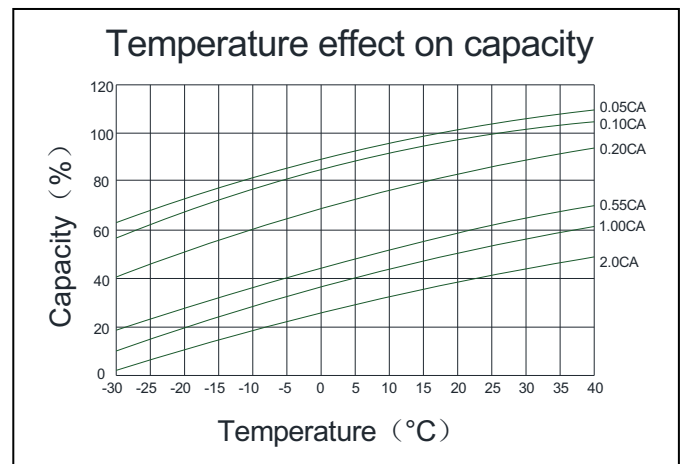
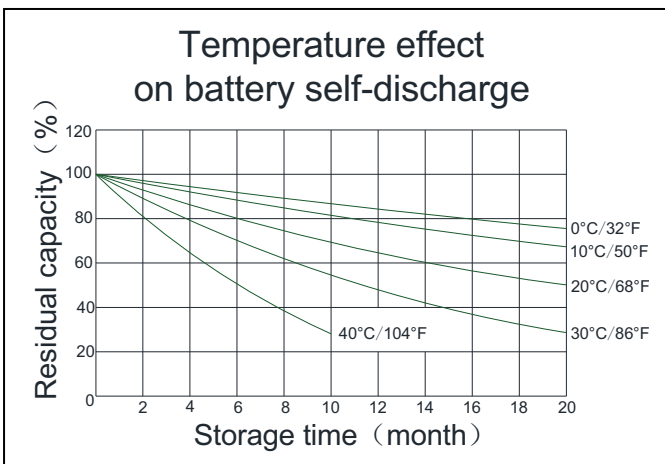
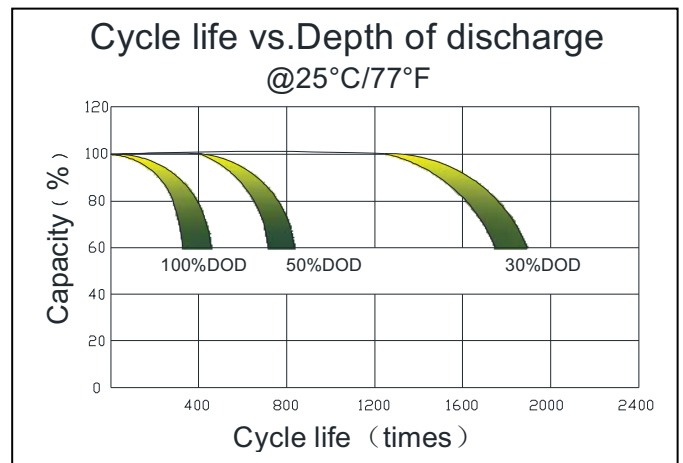
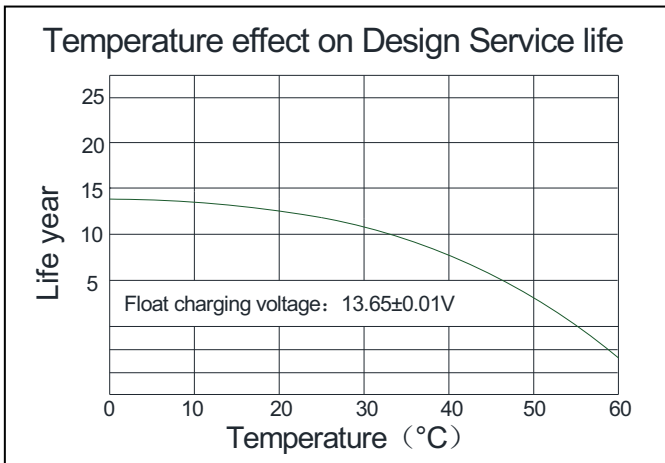
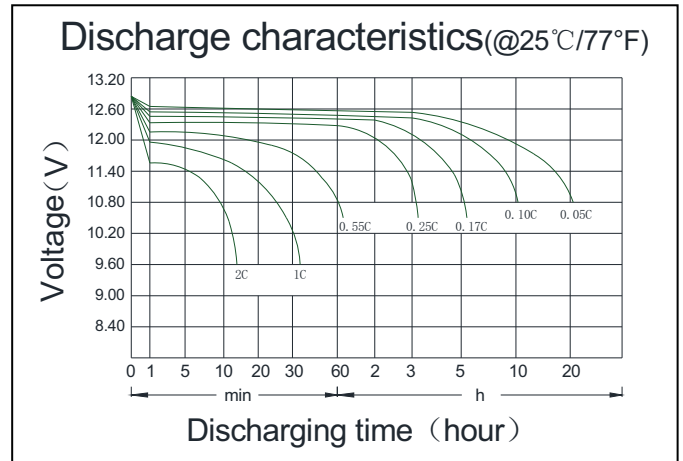
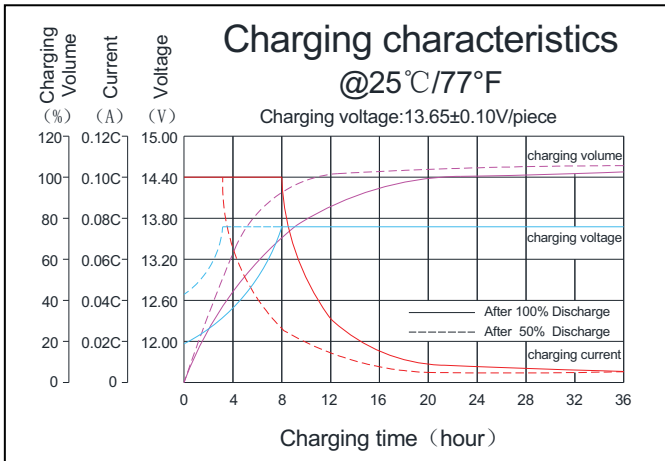

BATTERY CONSTRUCTION

Component	Positive plate	Negative plate	Container & Cover	Safety valve	Terminal	Separator	Electrolyte	Pillar seal
Features	Thick high Sn low Ca grid with special paste	Balanced Pb-Ca grid for improved recombination efficiency	ABS (UL94-V0 optional)	Flame Si-Rubbeand aging resistancer	Female Copper Insert M8(torque:7 ~9N.m)	Advanced AGM separator for high pressure cell design	Dilute high purity sulphuric acid	Two layers epoxy resin seal