



### GENERAL FEATURES

- Thick plate with high Tin low Calcium alloy
- High Reliability and Good Quality
- High gas recombination efficiency
- High Power Density
- Long Service Life, in Float or Cyclic

### APPLICATIONS

- Solar Systems
- Power station
- Telecom systems
- Cable TV Systems
- UPS & EPS
- Renewable energy system

### DIMENSIONS & WEIGHT

Length(mm)	173±1
Width(mm)	111±1
Height(mm)	329±1
Total Height(mm)	365±1
Weight(kg)	13.8±3%

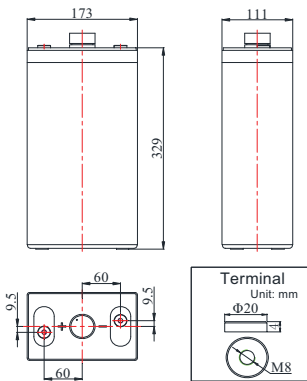

### COMPLIED STANDARDS

IEC 60896-21/22	JIS C8704
YD/T799	BS6290 part4
GB/T 19638	UL 1989

### TECHNICAL SPECIFICATIONS



Nominal Voltage		2V(1 cells per unit)
Design Floating Life @25°C		15 Years
Nominal Capacity @25°C (10 hour rate@24.0A,1.8V)		240Ah
Capacity @25°C	20 hour rate (12.72A,1.8V)	254.4Ah
	5 hour rate (42.2A,1.75V)	211Ah
	1 hour rate (153.8A,1.6V)	153.8Ah
Internal Resistance	Full Charged Battery@25°C	≤0.72mΩ
Ambient Temperature	Discharge	-20°C~50°C
	Charge	-20°C~50°C
	Storage	-20°C~50°C
Max.Discharge Current@25°C		1200A(5s)
Capacity affected by Temperature (10 hr Capacity)	40°C	105%
	25°C	100%
	0°C	85%
	-15°C	65%
Self-Discharge@25°C per Month		3%
Charge (Constant Voltage) @25°C	Standby Use	Initial Charging Current Less than 36A Voltage 2.23-2.27V
	Cycle Use	Initial Charging Current Less than 36A Voltage 2.33-2.37V

### BATTERY DISCHARGE TABEL

#### Discharge Constant Current per Cell (Amperes at 25°C)

F.V/Time	30min	45min	1h	2h	3h	4h	5h	6h	8h	10h	20h
1.60V	255.1	193.2	153.8	90.0	68.6	53.3	44.6	38.9	31.2	25.2	13.32
1.65V	241.7	185.8	148.8	87.1	66.5	52.1	43.9	38.2	31.0	24.7	13.20
1.70V	234.7	179.0	144.7	84.7	64.8	50.9	43.0	37.4	30.5	24.5	13.06
1.75V	224.4	171.1	139.4	82.6	63.4	49.7	42.2	36.7	30.2	24.2	12.94
1.80V	216.2	164.9	134.6	79.4	61.4	48.5	41.3	36.0	29.3	24.0	12.72

#### Discharge Constant Power per Cell (Watts at 25°C)

F.V/Time	30min	45min	1h	2h	3h	4h	5h	6h	8h	10h	20h
1.60V	492.2	367.0	296.2	170.6	131.3	102.2	86.2	75.1	61.4	49.2	26.2
1.65V	470.2	354.5	288.2	166.1	127.9	100.3	84.7	73.9	61.0	48.7	25.7
1.70V	450.2	343.2	278.4	162.2	125.0	98.4	83.5	73.0	60.0	48.2	25.4
1.75V	427.9	329.5	268.3	158.4	122.6	96.2	82.3	71.8	58.6	47.8	25.2
1.80V	409.9	318.5	259.7	153.1	119.3	94.1	80.6	70.6	57.4	47.5	25.0

**Note** The above data are average values, and can be obtained within 3 charge/discharge cycles. These are not minimum values. Cell and battery designs/specifications are subject to modification without notice. Contact **CBB** for the latest information.

### PERFORMANCE CHARACTERISTICS

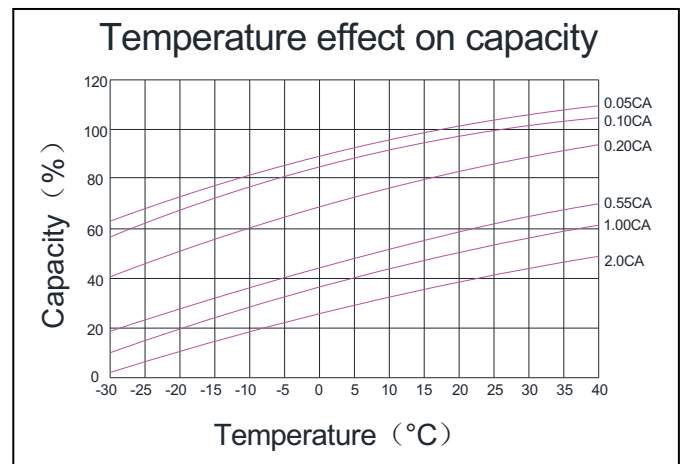
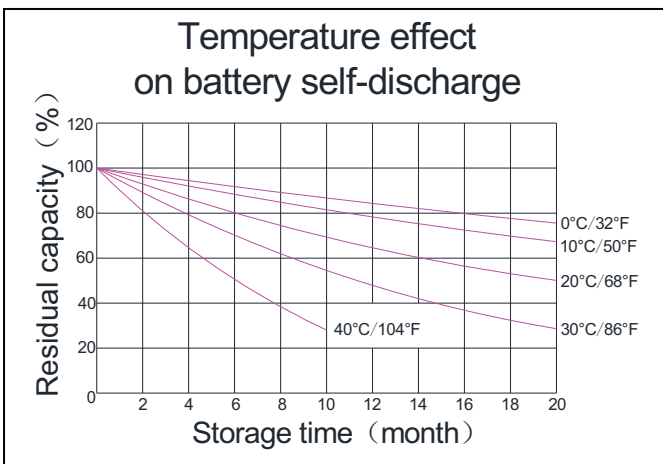
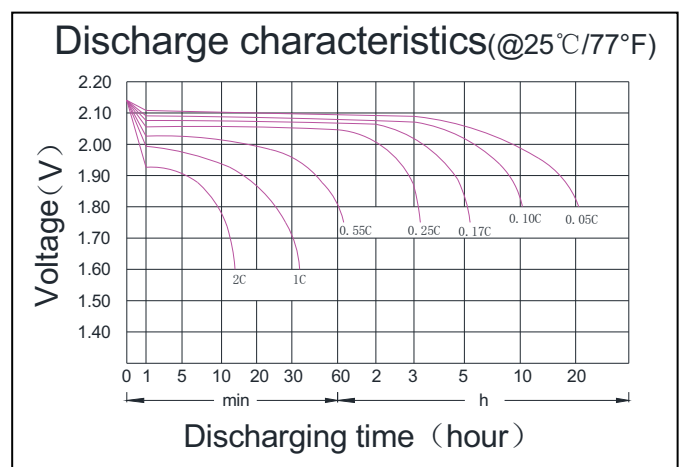
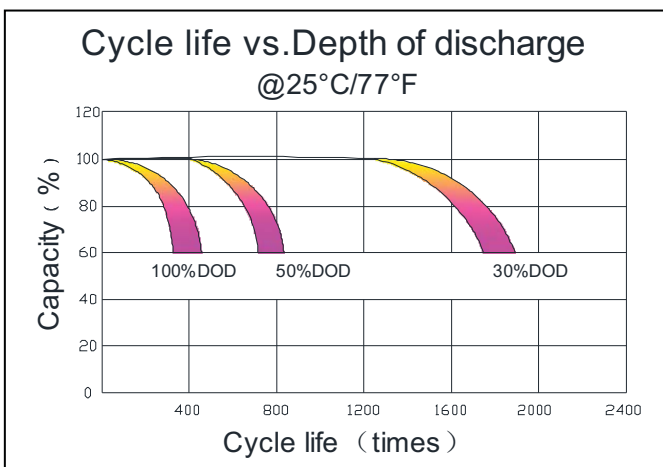
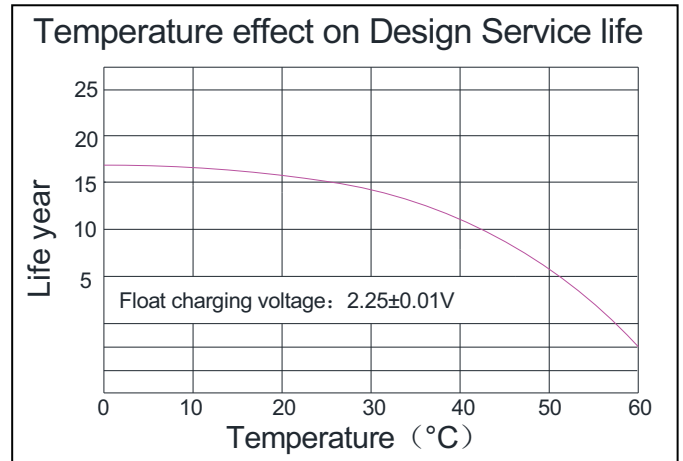
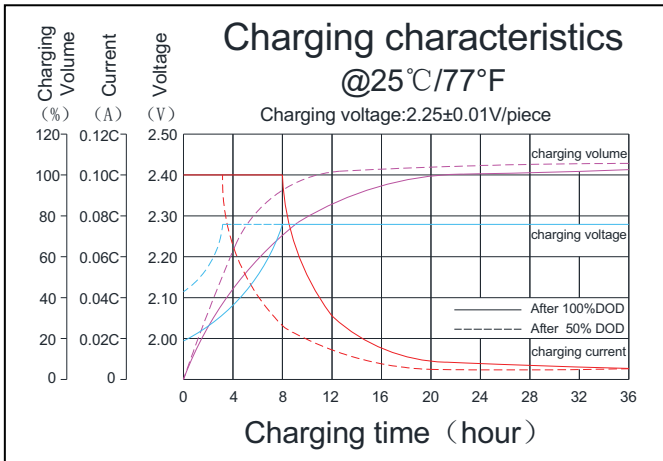

### BATTERY CONSTRUCTION

Component	Positive plate	Negative plate	Container & Cover	Safety valve	Terminal	Separator	Electrolyte	Pillar seal
Features	Thick high Sn low Ca grid with special paste	Balanced Pb-Ca grid for improved recombination efficiency	ABS (UL94-V0 optional)	Flame Si-Rubbeand aging resistancer	Female Copper Insert M8(torque:1 0~12N.m	Advanced AGM separator for high pressure cell design	Dilute high purity sulphuric acid	Two layers epoxy resin seal

**CBB Battery Technology Co.,Ltd.**

RM504,55 Hanxing Zhong Road,Zhongcun, Panyu,Guangzhou 511495 China

Tel: +86-020-84888946 Fax: +86-020-62824569

Copyright©2017 CBB Battery Technology Co., Ltd.

# Koyama®

www.cbb-battery.com