



for

LED



GooLED

GooLED-LUN-5830 Pin Fin LED Heat Sink Φ 58mm for Luminus

Features VS Benefits

- * The GooLED-LUN-5830 Luminus Pin Fin LED Heat Sinks are specifically designed for luminaires using the Luminus LED engines.
- * Mechanical compatibility with direct mounting of the LED engines to the LED cooler and thermal performance matching the lumen packages.
- * For spotlight and downlight designs from 500 to 1,600 lumen.
- * Thermal resistance range Rth 5.0°C/W.
- * Modular design with mounting holes foreseen for direct mounting of Luminus COB series.
- * Diameter 58mm - standard height 30mm, Other heights on request.
- * Forged from highly conductive aluminum.



Zhaga LED engine and radiator assembly is a unified future international standardization

- * Below you find an overview of Luminus COB's and LED modules which standard fit on the Pin Fin LED Heat Sinks.
- * In this way mechanical after work and related costs can be avoided, and lighting designers can standardize their designs on a limited number of LED Pin Fin LED Heat Sink.

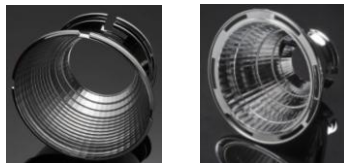
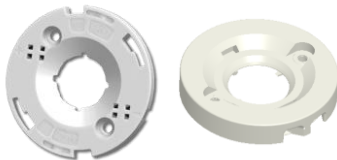

Luminus LED Modules directly Mounting Options

Luminus COB series.

- CXM-6-AC;
- CIM/CLM/CXM-9 -AC;
- With the Zhaga Book 11 holders for the green indicator marks.
- TE Connectivity Holder: 2213678-5;
- BJB Holder:47.319.6060.50;
- Without the holders for the pink indicator marks.
- Direct mounting with machine screws M3x6.5mm.

With the LEDiL products:

- Lena series: CN14xxx; C12xxx;
- Lenina series: CN14xxx; C12xxx;

Luminus COB series.

- CXM-11-AC;
- CIM/CLM/CXM-14;
- With the Zhaga Book 3 holders for the blue indicator marks.
- TE Connectivity Holder: 2213254-1;
- BJB Holder:47.319.2021.50;
- Without the holders for the red indicator marks.
- Direct mounting with machine screws M3x6.5mm.

With the LEDiL products:

- Lena series: CN12xxx;
- Lenina series: CN12xxx; C12xxx;

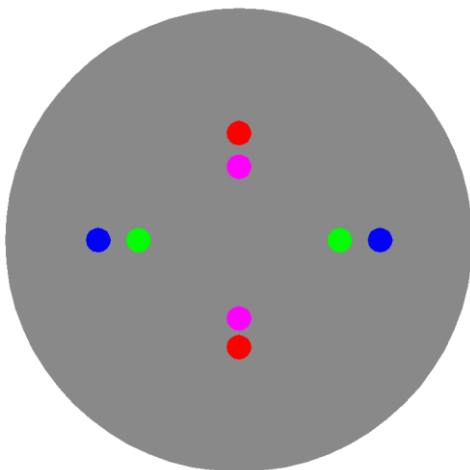

Mounting Options and Drawings & Dimensions

Example:GooLED-LUN-5830-B-1,2

Example:GooLED-LUN-58 1 - 2 - 3

1 Height (mm)

2 Anodising Color

B-Black

C-Clear

Z-Custom

3 Mounting Options - see graphics for details Combinations available

Ex.order code - 12

means option 1 and 2 combined

Notes:

- Mentioned models are an extraction of full product range.
- For specific mechanical adaptations please contact MingfaTech.
- MingfaTech reserves the right to change products or specifications without prior notice.

MOUNTING OPTION	Module type	Holder NO.	LEDiL products		THREAD	THREAD DEPTH	THREAD HOLE DISTANCE
			Lenina Series	Lena series			
1	CXM-6-AC; CIM/ CLM/CXM-9 -AC;	/	CN14xxx; C12xxx;	CN14xxx; C12xxx;	M3	6.5mm	19.0mm/ 2-@180°
2		BJB Holder 47.319.6060.50			M3	6.5mm	25.0mm/ 2-@180° (Zhaga book 11)
		TE Holder 2213678-5					
3	CXM-11; CIM/CLM/CXM-14	/	CN12xxx; C12xxx;	CN12xxx;	M3	6.5mm	26.8mm/ 2-@180°
4		BJB Holder 47.319.2021.50			M3	6.5mm	35.0mm/ 2-@180° (Zhaga book 3)
		TE Holder 2213254-1					

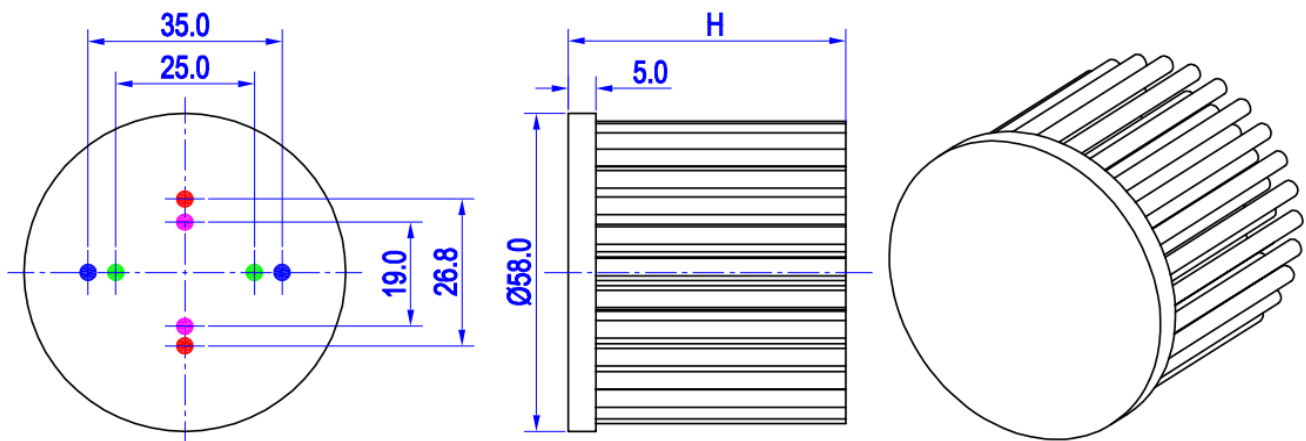



for

LED



GooLED

GooLED-LUN-5830 Pin Fin LED Heat Sink Φ 58mm for Luminus

The product data table

	Model No.	GooLED-LUN-5830
	Heatsink Size	Φ 58xH30mm
	Heatsink Material	AL1070
	Finish	Black Anodized
	Weight (g)	79.0
	Dissipated power (T _{hs-amb} ,50°C)	10.0 (W)
	Cooling surface area (mm ²)	27134
	Thermal Resistance (R _{hs-amb})	5.0 (°C/W)

The thermal data table

* Please be aware the dissipated power Pd is not the same as the electrical power Pe of a LED module.

*To calculate the dissipated power please use the following formula: Pd = Pe x (1-ηL).

Pd - Dissipated power ; Pe - Electrical power ; ηL = Light efficiency of the LED module;

Dissipated Power Pd(W)	Pd = Pe x (1-ηL)	Heat sink to ambient thermal resistance R _{hs-amb} (°C/W)	Heat sink to ambient temperature rise T _{hs-amb} (°C)
		GooLED-LUN-5830	
3.0		6.67	20.0
6.0		5.83	35.0
9.0		5.11	46.0
12.0		4.75	57.0
15.0		4.67	70.0

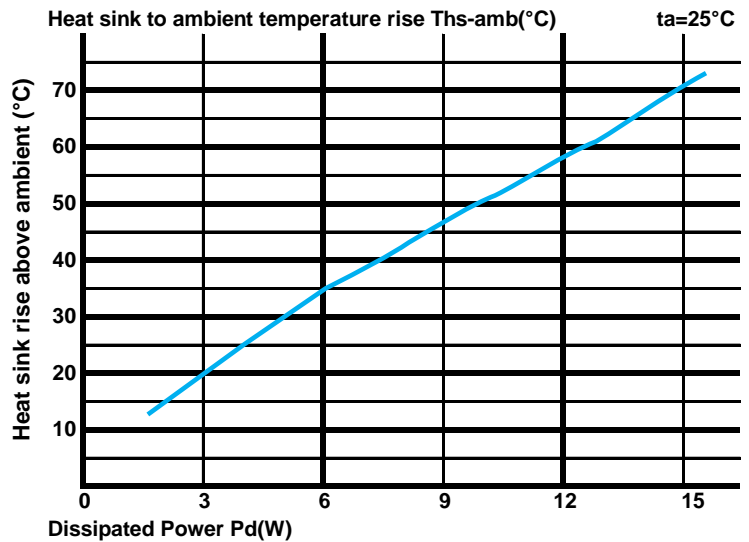

*The aluminum substrate side of the package outer shell is thermally connected to the heat sink via TIM (Thermal interface material).

MingFa recommends the use of a high thermal conductive interface between the LED module and the LED cooler.

Either thermal grease, A thermal pad or a phase change thermal pad thickness 0.1-0.15mm is recommended.

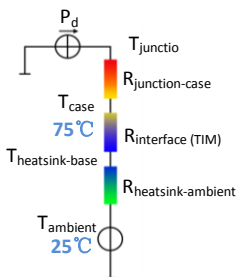

*Thermal resistance is a heat property and a measurement of a temperature difference by which an object or material resists a heat flow.

Geometric shapes are different, the thermal resistance is different. Formula: $\theta = (T_{hs} - T_a) / P_d$

θ - Thermal Resistance [°C/W]; T_{hs} - Heatsink temperature; T_a - Ambient temperature;

*The thermal resistance between the junction section of the light-emitting diode and the aluminum substrate side of the package outer shell is R_{junction-case}, the thermal resistance of the TIM outside the package is R_{interface (TIM)} [°C/W], the thermal resistance with the heat sink is R_{heatsink-ambient} [°C/W], and the ambient temperature is T_{ambient} [°C].

*Thermal resistances outside the package R_{interface (TIM)} and R_{heatsink-ambient} can be integrated into the thermal resistance R_{case-ambient} at this point. Thus, the following formula is also used:

$$T_{junction} = (R_{junction-case} + R_{case-ambient}) \cdot P_d + T_{ambient}$$