



for

LED



GooLED

GooLED-BRI-8630 Pin Fin LED Heat Sink Φ 86.5mm for Bridgelux

Features VS Benefits

- * The GooLED-BRI-8630 Bridgelux Pin Fin LED Heat Sinks are specifically designed for luminaires using the Bridgelux LED engines.
- * Mechanical compatibility with direct mounting of the LED engines to the LED cooler and thermal performance matching the lumen packages.
- * For spotlight and downlight designs from 1,200 to 3,200 lumen.
- * Thermal resistance range Rth 2.5°C/W.
- * Modular design with mounting holes foreseen for direct mounting of Bridgelux V Series™, Vero® SE Series, Vero® Series, H Series™ and Vesta™ Series LED engines.
- * Diameter 86.5mm - standard height 30mm Other heights on request.
- * Forged from highly conductive aluminum.

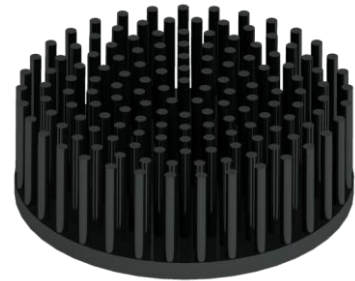

Zhaga LED engine and radiator assembly is a unified future international standardization

- * Below you find an overview of Bridgelux COB's and LED modules which standard fit on the Pin Fin LED Heat Sinks.
- * In this way mechanical after work and related costs can be avoided, and lighting designers can standardize their designs on a limited number of LED Pin Fin LED Heat Sink.

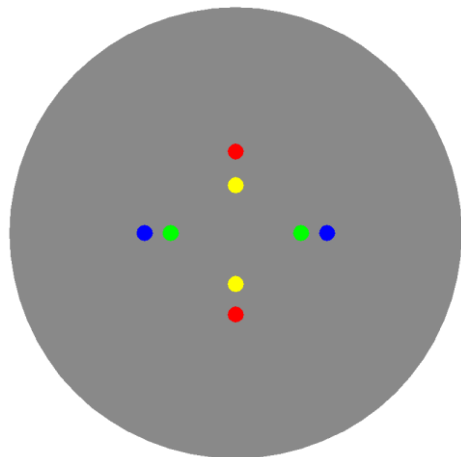
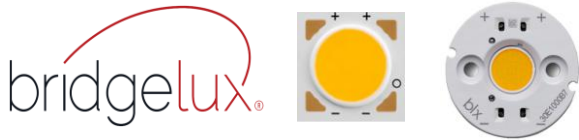

Bridgelux LED Modules directly Mounting Options

Bridgelux V13,V15,V18 LED Array Series:

- BXRE-20xxxxxx-x-xx; BXRE-40xxxxxx-x-xx;
- BXRE-27xxxxxx-x-xx; BXRE-50xxxxxx-x-xx;
- BXRE-30xxxxxx-x-xx; BXRE-57xxxxxx-x-xx;
- BXRE-35xxxxxx-x-xx; BXRE-65xxxxxx-x-xx;

With the Zhaga Book 3 Holders:
 BJB holder:47.319.2025.50; 47.319.2030.50;
 Direct mounting with machine screws M3x6.5mm, Blue indicator marks.

With the LEDiL products:
 Olivia series: FN14637-S;
 Ronda series: FN15xxx-xx;

Bridgelux Vero® Series Vero 10, Vero 13 LED Array and Vero® SE Series Vero 10 SE, Vero 13 SE LED Array

- BXRC-27xxxxxx-x-xx; BXRC-50xxxxxx-x-xx;
- BXRC-30xxxxxx-x-xx; BXRC-57xxxxxx-x-xx;
- BXRC-35xxxxxx-x-xx; BXRC-65xxxxxx-x-xx;
- BXRC-40xxxxxx-x-xx;

With the Bridgelux Holder:
 Direct mounting with machine screws M3x6.5mm.
 Vero 10 for the yellow indicator mark, Vero 13 for the red indicator mark.

With the LEDiL products:
 Olivia series: FN14637-S; FN14828-M;
 Ronda series: FN15xxx-xx;

Bridgelux® H Series™ H6, H9 LED Array:

- BXRH-27xxxxxx-x-xx; BXRH-35xxxxxx-x-xx;
- BXRH-30xxxxxx-x-xx; BXRH-40xxxxxx-x-xx;

With the Zhaga Book 11 Holders:
 BJB holder:47.319.6120.50; 47.319.6104.50;
 Direct mounting with machine screws M3x6.5mm, Green indicator marks.
 With the LEDiL products: Ronda series: FN15xxx-xx;

Bridgelux® Vesta™ Series Dim-To-Warm 9mm Array

- BXRV-DR-1830H-1000-x-13;

With the Zhaga Book 11 Holders:
 BJB holder:47.319.6180.50;
 Direct mounting with machine screws M3x6.5mm, Green indicator marks.

Mounting Options and Drawings & Dimensions

Example:GooLED-BRI-8630-B-1,2

Example:GooLED-BRI-86 **1** - **2** - **3**

- 1** Height (mm)
- 2** Anodising Color
 - B-Black
 - C-Clear
 - Z-Custom
- 3** Mounting Options - see graphics for details Combinations available
Ex.order code - 12
means option 1 and 2 combined

Notes:

- Mentioned models are an extraction of full product range.
- For specific mechanical adaptations please contact MingfaTech.
- MingfaTech reserves the right to change products or specifications without prior notice.

MOUNTING OPTION	Module type	Holder NO.	LEDiL products		THREAD	THREAD DEPTH	THREAD HOLE DISTANCE
			Olivia series	Ronda series			
1	Vero 10 Vero SE 10	Bridgelux	/	/	M3	6.5mm	19.0mm/ 2-@180°
2	Vesta™ Series 9mm	BJB Holder 47.319.6180.50	/	/	M3	6.5mm	25.0mm/ 2-@180° (Zhaga book 11)
	H6	BJB Holder 47.319.6120.50	/	/			
	H9	BJB Holder 47.319.6104.50	/	FN15xxx-xx;			
3	Vero 13 Vero SE 13	Bridgelux	FN14637-S; FN14828-M;	FN15xxx-xx;	M3	6.5mm	31.4mm/ 2-@180°
4	V15, V18	BJB Holder 47.319.2224.50	FN14637-S	/	M3	6.5mm	35.0mm/ 2-@180° (Zhaga book3)
	V13	BJB Holder 47.319.2025.50		FN15xxx-xx;			

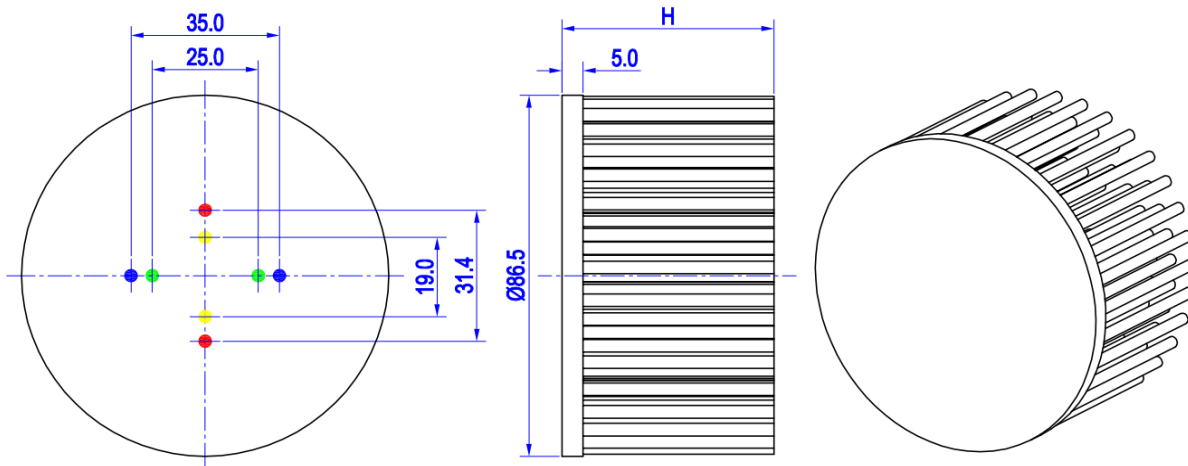



for

LED



GooLED

GooLED-BRI-8630 Pin Fin LED Heat Sink Φ86.5mm for Bridgelux

The product data table

	Model No.	GooLED-BRI-8630
	Heatsink Size	Φ86.5xH30mm
	Heatsink Material	AL1070
	Finish	Black Anodized
	Weight (g)	152.0
	Dissipated power (T_{hs-amb},50°C)	20.0 (W)
	Cooling surface area (mm²)	48926
	Thermal Resistance (R_{hs-amb})	2.5 (°C/W)

The thermal data table

* Please be aware the dissipated power Pd is not the same as the electrical power Pe of a LED module.

*To calculate the dissipated power please use the following formula: Pd = Pe x (1-ηL).

Pd - Dissipated power ; Pe - Electrical power ; ηL = Light efficiency of the LED module;

Dissipated Power Pd(W)	Pd = Pe x (1-ηL)	Heat sink to ambient thermal resistance R _{hs-amb} (°C/W)	Heat sink to ambient temperature rise T _{hs-amb} (°C)
	GooLED-BRI-8630		
6.0		4.00	24.0
12.0		2.92	35.0
18.0		2.56	46.0
24.0		2.33	56.0
32.0		2.03	65.0

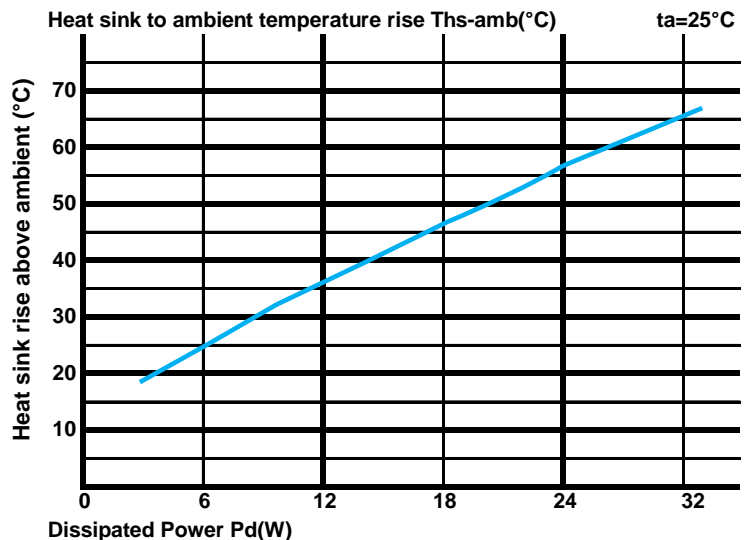

*The aluminum substrate side of the package outer shell is thermally connected to the heat sink via TIM (Thermal interface material).

MingFa recommends the use of a high thermal conductive interface between the LED module and the LED cooler.

Either thermal grease, A thermal pad or a phase change thermal pad thickness 0.1-0.15mm is recommended.

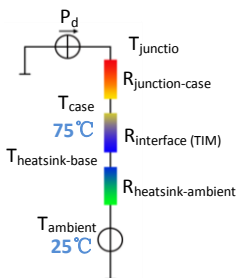

*Thermal resistance is a heat property and a measurement of a temperature difference by which an object or material resists a heat flow.

Geometric shapes are different, the thermal resistance is different. Formula: $\theta = (T_{hs} - T_a) / P_d$

θ - Thermal Resistance [°C/W] ; T_{hs} - Heatsink temperature ; T_a - Ambient temperature ;

*The thermal resistance between the junction section of the light-emitting diode and the aluminum substrate side of the package outer shell is R_{junction-case}, the thermal resistance of the TIM outside the package is R_{interface (TIM)} [°C/W], the thermal resistance with the

heat sink is R_{heatsink-ambient} [°C/W], and the ambient temperature is T_{ambient} [°C].

*Thermal resistances outside the package R_{interface (TIM)} and R_{heatsink-ambient} can be integrated into the thermal resistance R_{case-ambient} at this point. Thus, the following formula is also used:

$$T_{junction} = (R_{junction-case} + R_{case-ambient}) \cdot P_d + T_{ambient}$$

